

C3000 MX 3.00 CONNECTOR

3.00mm Pitch/Disconnectable Crimp style connectors

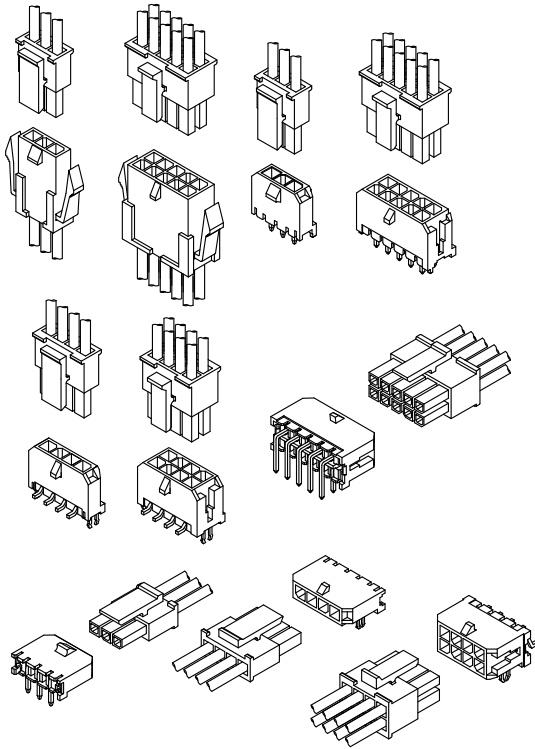

- Secure locking structure
- Low insertion force
- Suction area for picking up
- Improvement of engagement with prying

Specifications:

- Current rating: 5.0 A / AC,DC
- Voltage rating: 600 V AC/DC
- Temperature range: -25°C ~ +105°C
(including temperature rise in applying electrical current)
- Contact resistance: Initial value/ 20mΩ max
Insulation resistance: 1000 MΩ min
Withstanding voltage: 1500 VAC/minute
Applicable wire: Conductor size/ AWG#24~#18
Insulation O.D./ 1.30 to 1.95 mm
- * Compliant with RoHS2/ REACH
- * Refer to "General Instruction and Notice when using Terminals and Connectors"
- * Contact CSG for details

Material:

Housing: PA66/UL94-V0/ V2;Color:Black
Terminal: Phosphor/Brass C1100/ Gold-Plated/ Tin-plated
DIP Wafer Housing: PA66/ PA46/ LCP,UL94-V0;Color:Black
DIP Wafer Pin: Brass/ C1100 Tin-plated/ Gold-Plated
DIP Wafer Fixed Foot: Brass/ Tin-plated
SMT Wafer Housing: LCP,UL94-V0;Color:Black
SMT Wafer Pin: Brass/ C1100 Tin-plated/ Gold-Plated
SMT Wafer Fixed Foot: Brass/ Tin-plated

- Note: 1. The above figure is the figure viewed from the connector mounting side.
2. Tolerances are non-cumulative: ±0.08 mm for all centers.
3. The dimensions above should serve as a guideline. Contact CSG for details.

CSG

C3000 MX 3.00

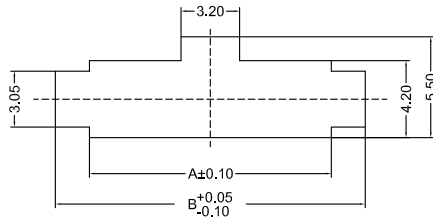
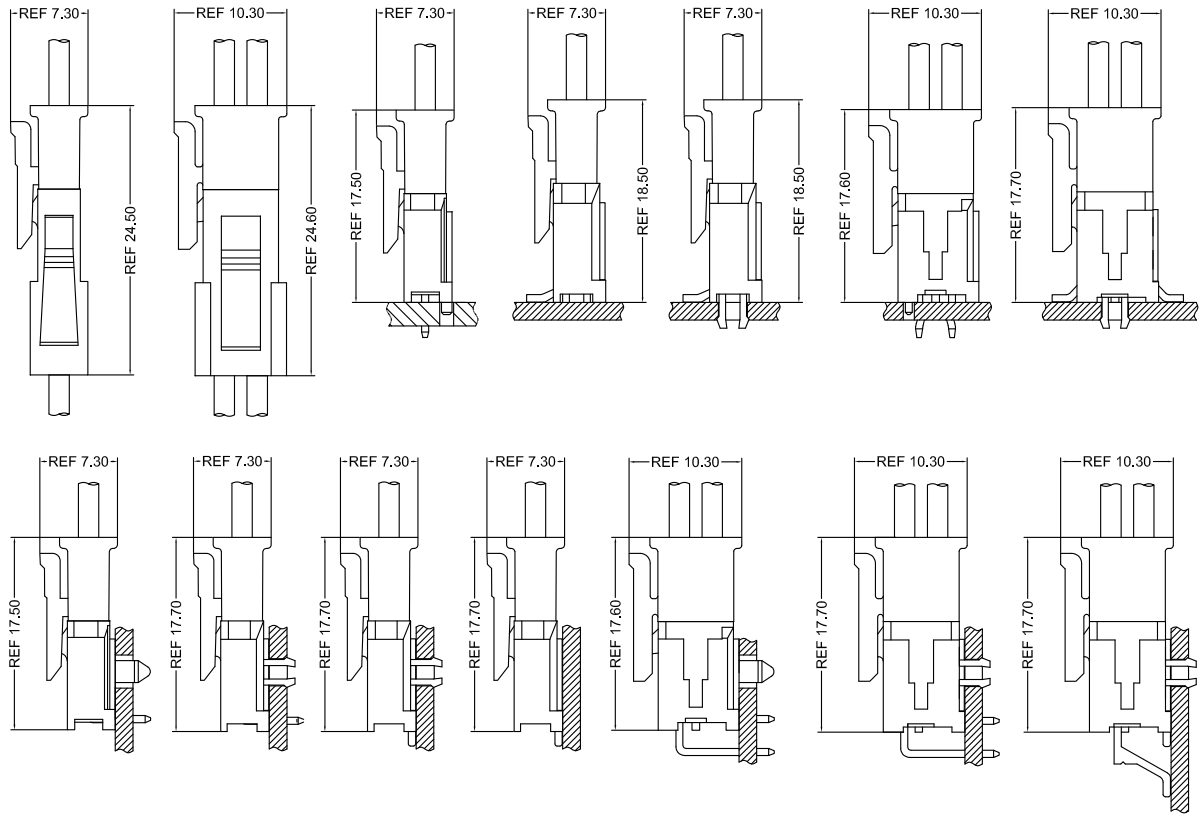

SINGLE ROW
RECOMMENDED PANEL CUT-OUT
 (DESIGNED FOR 1.57mm TO 2.30mm THICK
 STAMPED PANEL OR PRINTED CIRCUIT BOARD)

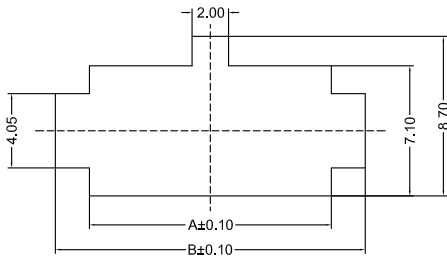

DUAL ROW
RECOMMENDED PANEL CUT-OUT
 (DESIGNED FOR 1.40mm TO 2.54mm THICK
 STAMPED PANEL OR PRINTED CIRCUIT BOARD)

CSG PART NO.	Dimension mm	
	A	B
C3000HM002ADP60005	4.20	7.90
C3000HM003ADP60005	7.20	10.90
C3000HM004ADP60005	10.20	13.90
C3000HM005ADP60005	13.20	16.90
C3000HM006ADP60005	16.20	19.90
C3000HM007ADP60005	19.20	22.90
C3000HM008ADP60005	22.20	25.90
C3000HM009ADP60005	25.20	28.90
C3000HM010ADP60005	28.20	31.90
C3000HM011ADP60005	31.20	34.90
C3000HM012ADP60005	34.20	37.90
C3000HM201ADP60005	37.20	40.90



C3000 MX 3.00

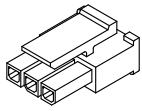

C3000HF0XX

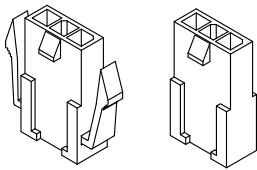
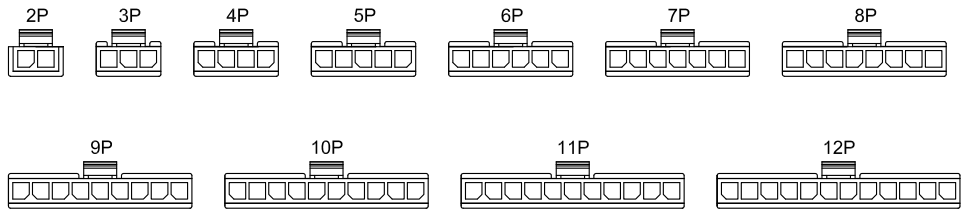

C3000HM0XX

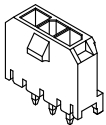
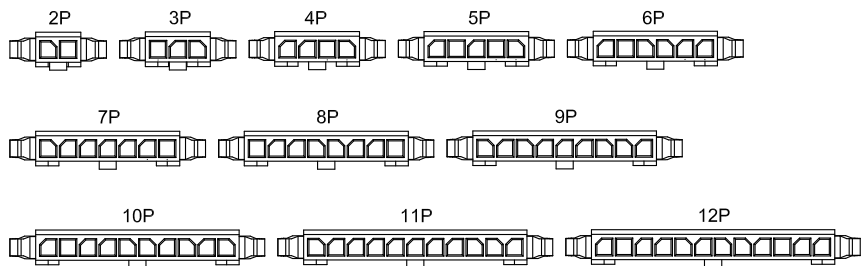

C3000VD0XX

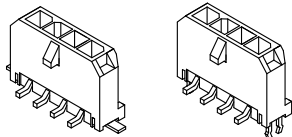
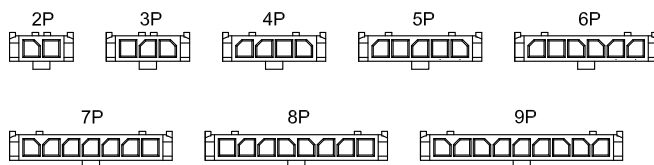

C3000VS0XX

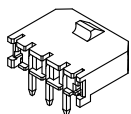
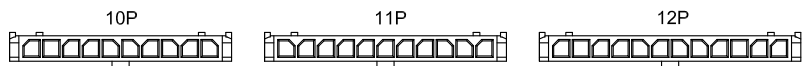

C3000RD0XX

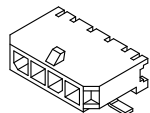
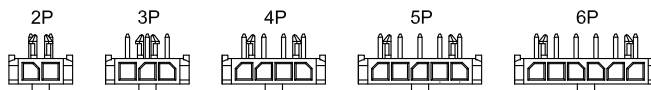

C3000RS0XX

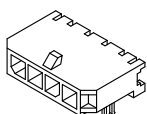
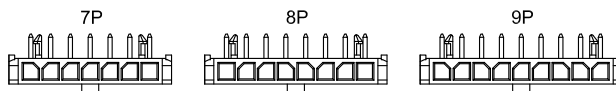

C3000RS0XX

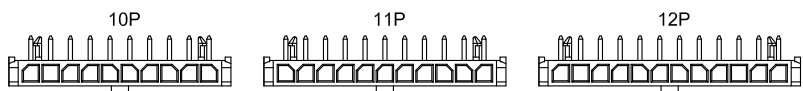

C3000 MX 3.00

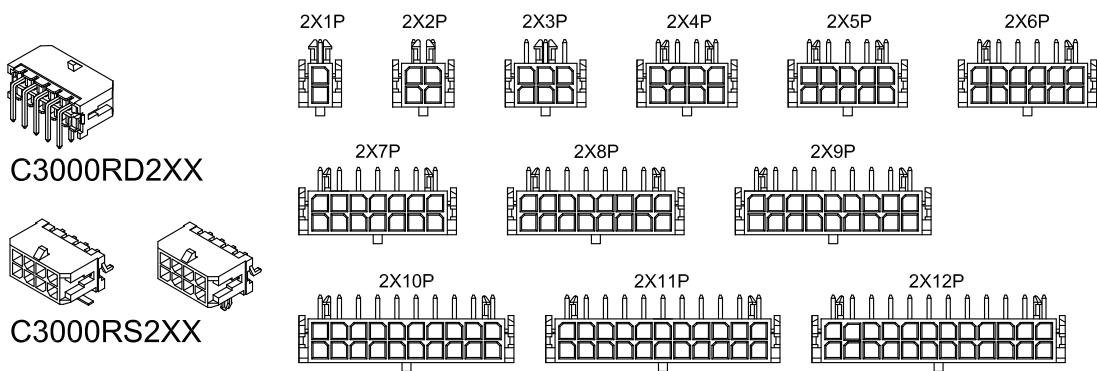
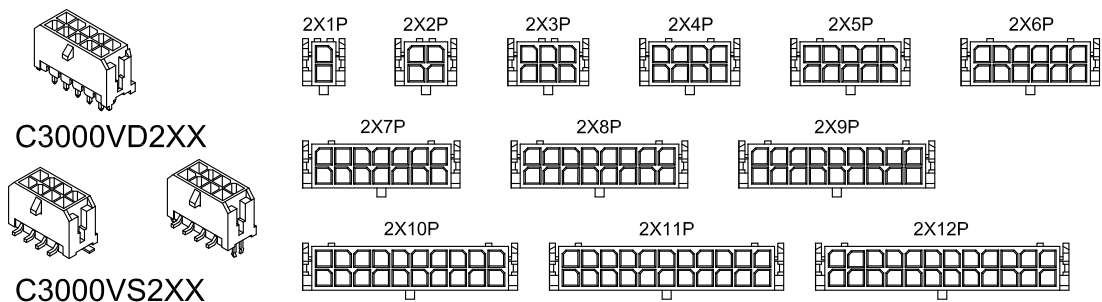
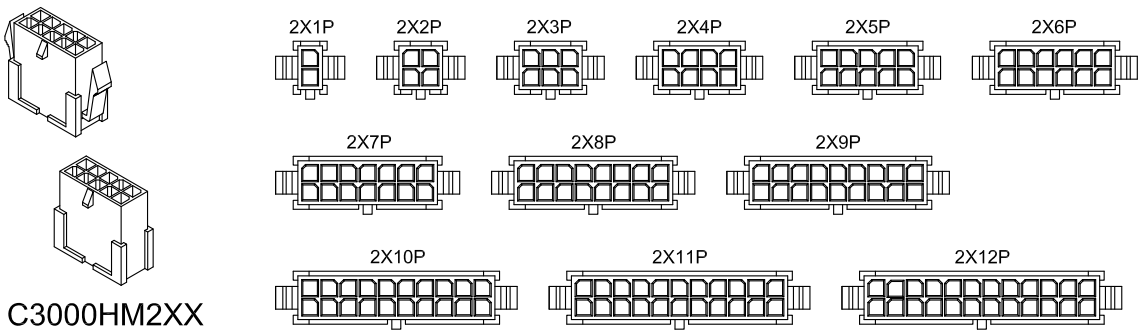
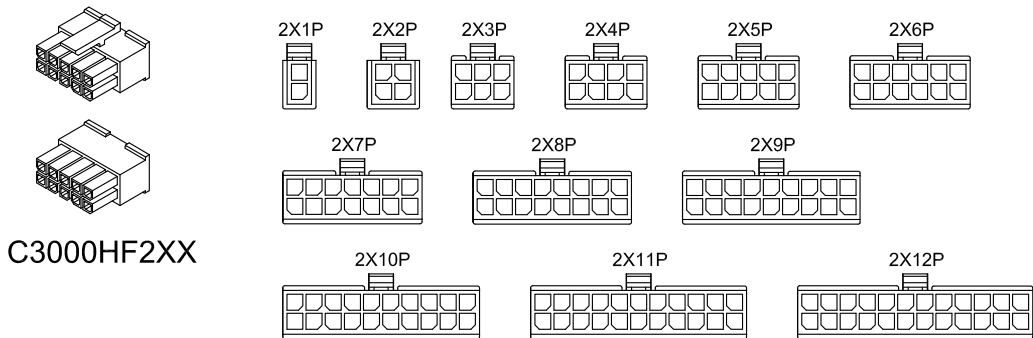

C3000 MX 3.00

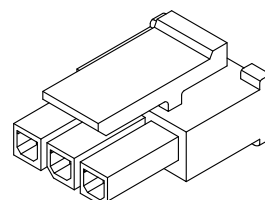
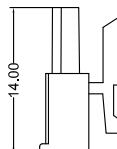
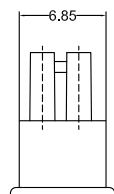
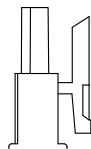
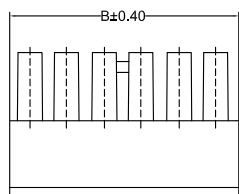
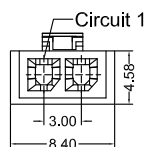
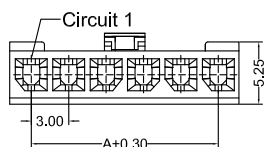

3P-12P

2P

C3000HF 0XX AK P6 0 XXX
 PIN 005=5PINS
 SPECIAL: AK=BUCKLE
 Material P6=PA66 94V-2
 Code 005 079
 Color 0=Black

CSG PART NO.	Dimension mm		Q'ty/BAG
	A	B	
C3000HF002AKP60XXX	3.00	6.85	1000PCS
C3000HF003AKP60XXX	6.00	9.85	1000PCS
C3000HF004AKP60XXX	9.00	12.85	1000PCS
C3000HF005AKP60XXX	12.00	15.85	1000PCS
C3000HF006AKP60XXX	15.00	18.85	1000PCS
C3000HF007AKP60XXX	18.00	21.85	1000PCS
C3000HF008AKP60XXX	21.00	24.85	1000PCS
C3000HF009AKP60XXX	24.00	27.85	1000PCS
C3000HF010AKP60XXX	27.00	30.85	1000PCS
C3000HF011AKP60XXX	30.00	33.85	1000PCS
C3000HF012AKP60XXX	33.00	36.85	1000PCS

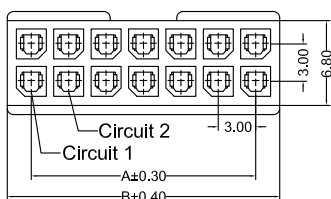
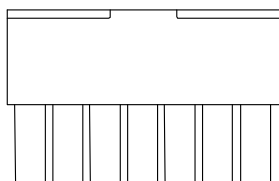

C3000HF 2XX AA P6 0 079
 PIN 205=2X5PINS
 SPECIAL: AA=NO Special
 Material P6=PA66 94V-2
 Code 079
 Color 0=Black

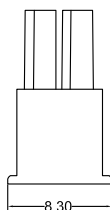
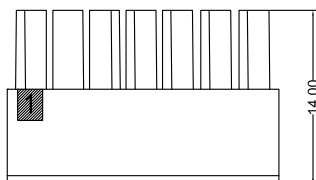
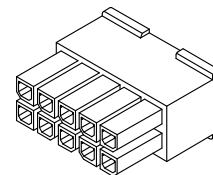

CSG PART NO.	Dimension mm		Q'ty/BAG
	A	B	
C3000HF203AAP60079	6.00	9.85	1000PCS
C3000HF204AAP60079	9.00	12.85	1000PCS
C3000HF205AAP60079	12.00	15.85	1000PCS
C3000HF206AAP60079	15.00	18.85	1000PCS
C3000HF207AAP60079	18.00	21.85	1000PCS
C3000HF208AAP60079	21.00	24.85	1000PCS
C3000HF209AAP60079	24.00	27.85	1000PCS
C3000HF210AAP60079	27.00	30.85	1000PCS
C3000HF211AAP60079	30.00	33.85	1000PCS
C3000HF212AAP60079	33.00	36.85	1000PCS



C3000 MX 3.00

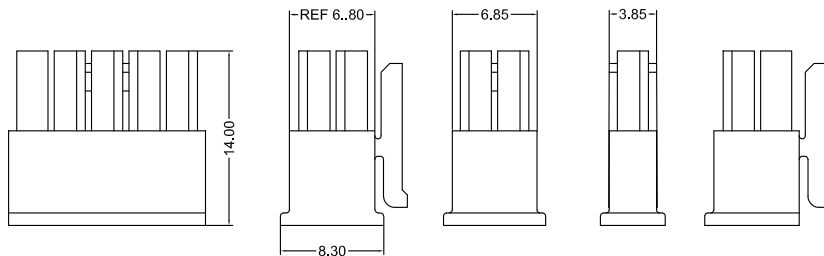
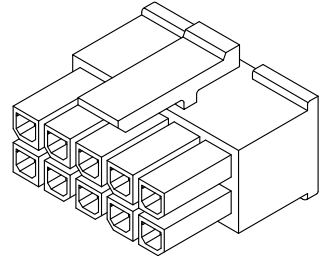
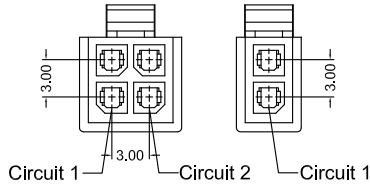
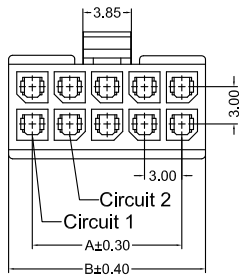

CSG PART NO.	Dimension mm		Q'ty/BAG
	A	B	
C3000HF201AKP60XXX	3.85	3.85	1000PCS
C3000HF202AKP60XXX	3.00	6.85	1000PCS
C3000HF203AKP60XXX	6.00	9.85	1000PCS
C3000HF204AKP60XXX	9.00	12.85	1000PCS
C3000HF205AKP60XXX	12.00	15.85	1000PCS
C3000HF206AKP60XXX	15.00	18.85	1000PCS
C3000HF207AKP60XXX	18.00	21.85	1000PCS
C3000HF208AKP60XXX	21.00	24.85	1000PCS
C3000HF209AKP60XXX	24.00	27.85	1000PCS
C3000HF210AKP60XXX	27.00	30.85	1000PCS
C3000HF211AKP60XXX	30.00	33.85	1000PCS
C3000HF212AKP60XXX	33.00	36.85	1000PCS

C3000HF 2XX AK P6 0 XXX
 PIN 205=2X5PINS
 SPECIAL AK=BUCKLE
 Material P6=PA66 94V-2
 Code 005
 079
 Color 0=Black

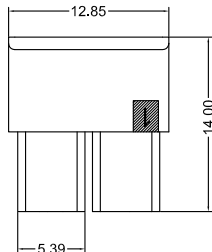
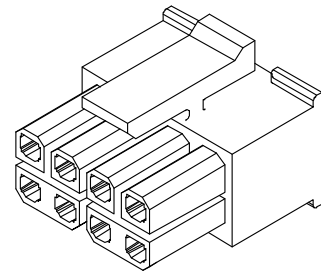
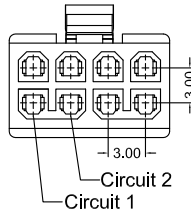
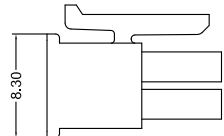
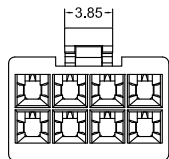
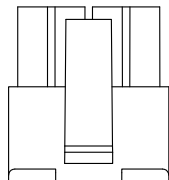

C3000HF 0XX AI P6 0 079
 PIN 005=5PINS
 SPECIAL AI=Conjoined
 Material P6=PA66 94V-2
 Code 079
 Color 0=Black



C3000 MX 3.00

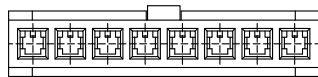
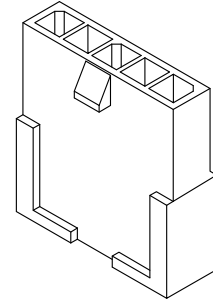
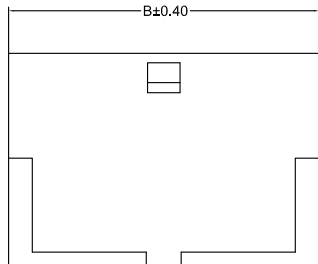
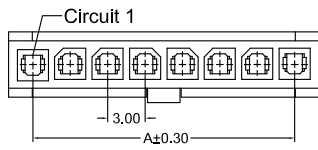

C3000HM 0XX AA P6 0 005
 PIN
 005=5PINS
 SPECIAL
 AA=NO Special
 Material
 P6=PA66 94V-2
 Code
 005
 Color
 0=Black

CSG PART NO.	Dimension mm		Q'ty/BAG
	A	B	
C3000HM002AAP60005	3.00	6.85	1000PCS
C3000HM003AAP60005	6.00	9.85	1000PCS
C3000HM004AAP60005	9.00	12.85	1000PCS
C3000HM005AAP60005	12.00	15.85	1000PCS
C3000HM006AAP60005	15.00	18.85	1000PCS
C3000HM007AAP60005	18.00	21.85	1000PCS
C3000HM008AAP60005	21.00	24.85	1000PCS
C3000HM009AAP60005	24.00	27.85	1000PCS
C3000HM010AAP60005	27.00	30.85	1000PCS
C3000HM011AAP60005	30.00	33.85	1000PCS
C3000HM012AAP60005	33.00	36.85	1000PCS

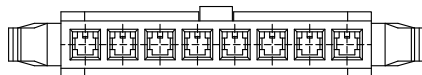
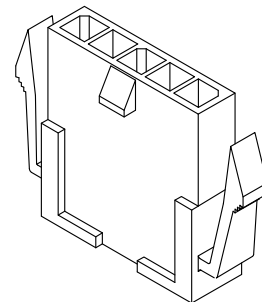
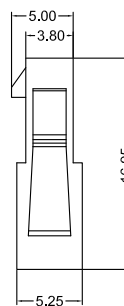
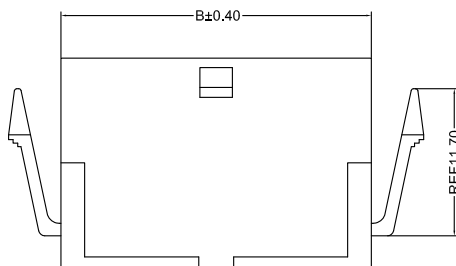
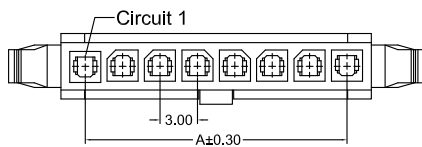

C3000HM 0XX AD P6 0 005
 PIN
 005=5PINS
 SPECIAL
 AD=With Wings
 Material
 P6=PA66 94V-2
 Code
 005
 Color
 0=Black

CSG PART NO.	Dimension mm		Q'ty/BAG
	A	B	
C3000HM002ADP60005	3.00	6.85	1000PCS
C3000HM003ADP60005	6.00	9.85	1000PCS
C3000HM004ADP60005	9.00	12.85	1000PCS
C3000HM005ADP60005	12.00	15.85	1000PCS
C3000HM006ADP60005	15.00	18.85	1000PCS
C3000HM007ADP60005	18.00	21.85	1000PCS
C3000HM008ADP60005	21.00	24.85	1000PCS
C3000HM009ADP60005	24.00	27.85	1000PCS
C3000HM010ADP60005	27.00	30.85	1000PCS
C3000HM011ADP60005	30.00	33.85	1000PCS
C3000HM012ADP60005	33.00	36.85	1000PCS



C3000 MX 3.00

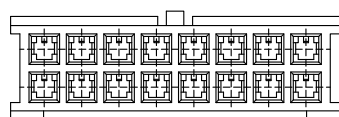
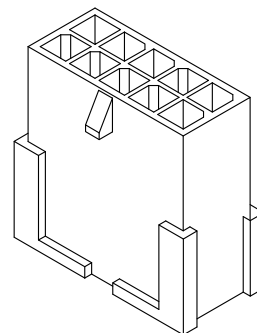
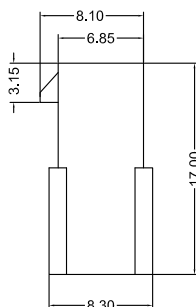
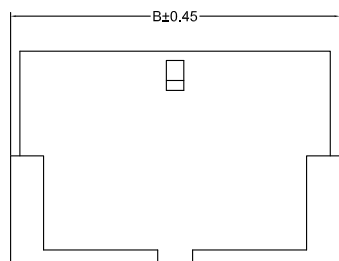
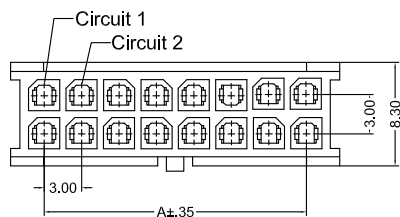

C3000HM 2XX AA P6 0 005
 PIN
 205=2X5PINS
 SPECIAL
 AA=NO Special
 Material
 P6=PA66 94V-2

Code
 005
 Color
 0=Black

CSG PART NO.	Dimension mm		Q'ty/BAG
	A	B	
C3000HM201AAP60005	5.30	8.30	1000PCS
C3000HM202AAP60005	3.00	8.30	1000PCS
C3000HM203AAP60005	6.00	11.30	1000PCS
C3000HM204AAP60005	9.00	14.30	1000PCS
C3000HM205AAP60005	12.00	15.85	1000PCS
C3000HM206AAP60005	15.00	18.85	1000PCS
C3000HM207AAP60005	18.00	21.85	1000PCS
C3000HM208AAP60005	21.00	24.85	1000PCS
C3000HM209AAP60005	24.00	27.85	1000PCS
C3000HM210AAP60005	27.00	30.85	1000PCS
C3000HM211AAP60005	30.00	33.85	1000PCS
C3000HM212AAP60005	33.00	36.85	1000PCS

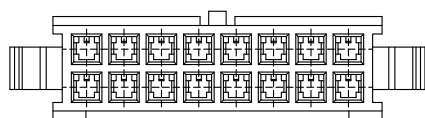
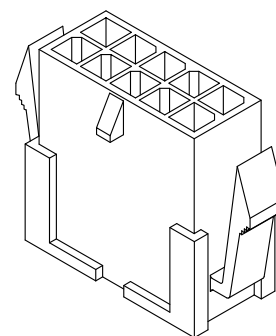
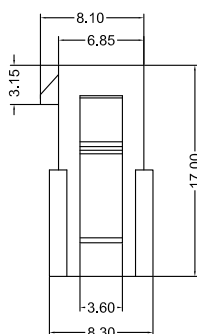
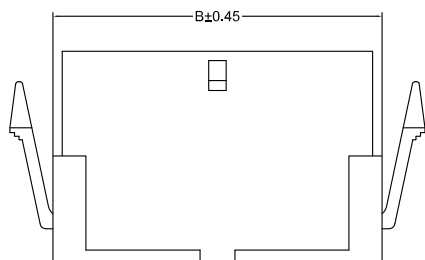
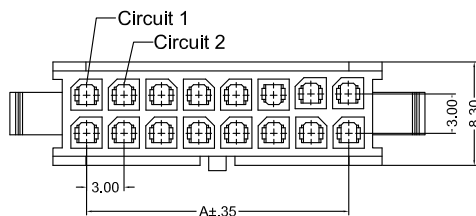

C3000HM 2XX AD P6 0 005
 PIN
 205=2X5PINS
 SPECIAL
 AD=With Wings
 Material
 P6=PA66 94V-2

Code
 005
 Color
 0=Black

CSG PART NO.	Dimension mm		Q'ty/BAG
	A	B	
C3000HM201ADP60005	5.30	8.30	1000PCS
C3000HM202ADP60005	3.00	8.30	1000PCS
C3000HM203ADP60005	6.00	11.30	1000PCS
C3000HM204ADP60005	9.00	14.30	1000PCS
C3000HM205ADP60005	12.00	15.85	1000PCS
C3000HM206ADP60005	15.00	18.85	1000PCS
C3000HM207ADP60005	18.00	21.85	1000PCS
C3000HM208ADP60005	21.00	24.85	1000PCS
C3000HM209ADP60005	24.00	27.85	1000PCS
C3000HM210ADP60005	27.00	30.85	1000PCS
C3000HM211ADP60005	30.00	33.85	1000PCS
C3000HM212ADP60005	33.00	36.85	1000PCS



C3000 MX 3.00

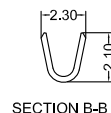
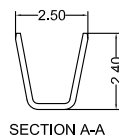
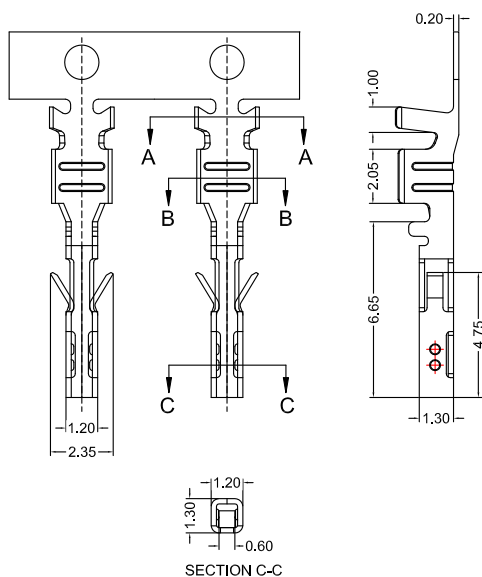

C3000 M 0 X XX 002

Type
M=Female Terminal

SPECIAL
O=NO Special

Material
A=Phosphor
H=C1100

Finish
TP=Tin-Plated
GF=Gold-Plated

Code
002

CSG PART NO.	Wire Range	Insulation O.D.	Q'ty/Reel
C3000M0XTP002	AWG#20-#24	1.85mm(max)	10000PCS
C3000M0XGF002	AWG#20-#24	1.85mm(max)	10000PCS

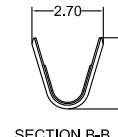
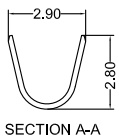
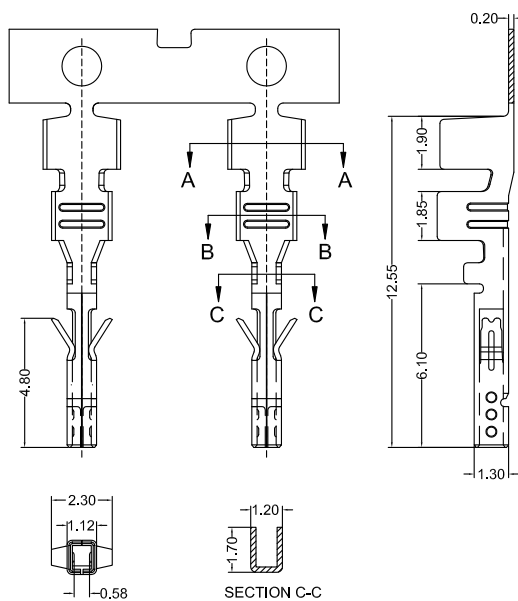

C3000 M H X XX 002

Type
M=Female Terminal

SPECIAL
H=High

Material
A=Phosphor
H=C1100

Finish
TP=Tin-Plated
GF=Gold-Plated

Code
002

CSG PART NO.	Wire Range	Insulation O.D.	Q'ty/Reel
C3000MHXTP002	AWG#16-#20	2.05mm(max)	10000PCS
C3000MHXGF002	AWG#16-#20	2.05mm(max)	10000PCS



C3000 MX 3.00

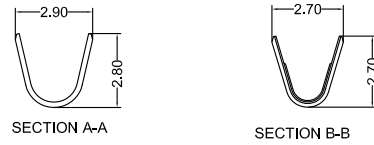
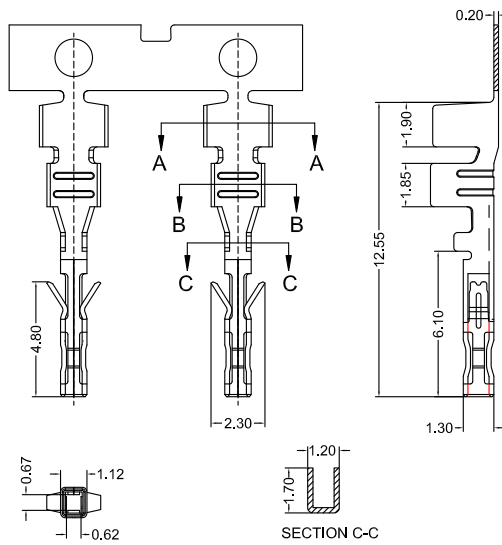

C3000 M H X XX 003

Type
M=Female Terminal

SPECIAL
H=High

Material
A=Phosphor

Finish
TP=Tin-Plated
GF=Gold-Plated

Code
003

CSG PART NO.	Wire Range	Insulation O.D.	Q'ty/Reel
C3000MHATP003	AWG#16-#20	2,05mm(max)	10000PCS
C3000MHAGF003	AWG#16-#20	2,05mm(max)	10000PCS

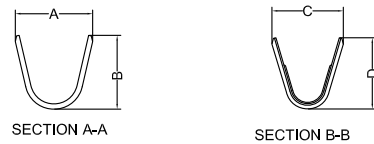
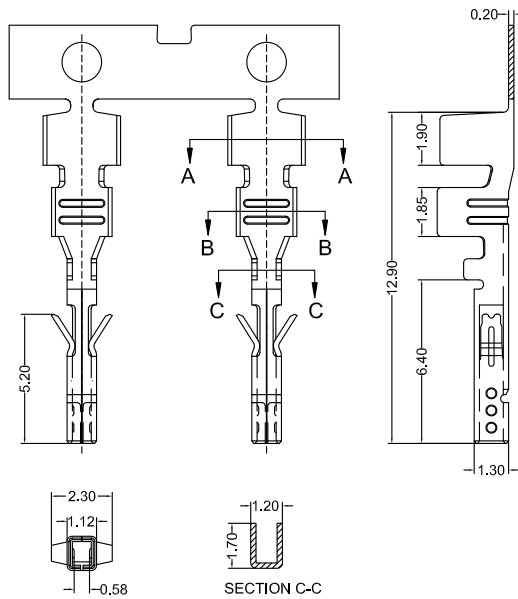

C3000 M X A TP 001

Type
M=Female Terminal

SPECIAL
O=NO Special
H=High

Material
A=Phosphor

Finish
TP=Tin-Plated

Code
001

CSG PART NO.	A	B	C	C	Wire Range	Insulation O.D.	Q'ty/Reel
C3000MOATP001	2,60	2,60	2,10	2,10	AWG#20-#24	1,85mm(max)	10000PCS
C3000MHAGF001	2,90	2,80	2,70	2,70	AWG#16-#20	2,05mm(max)	10000PCS



C3000 MX 3.00

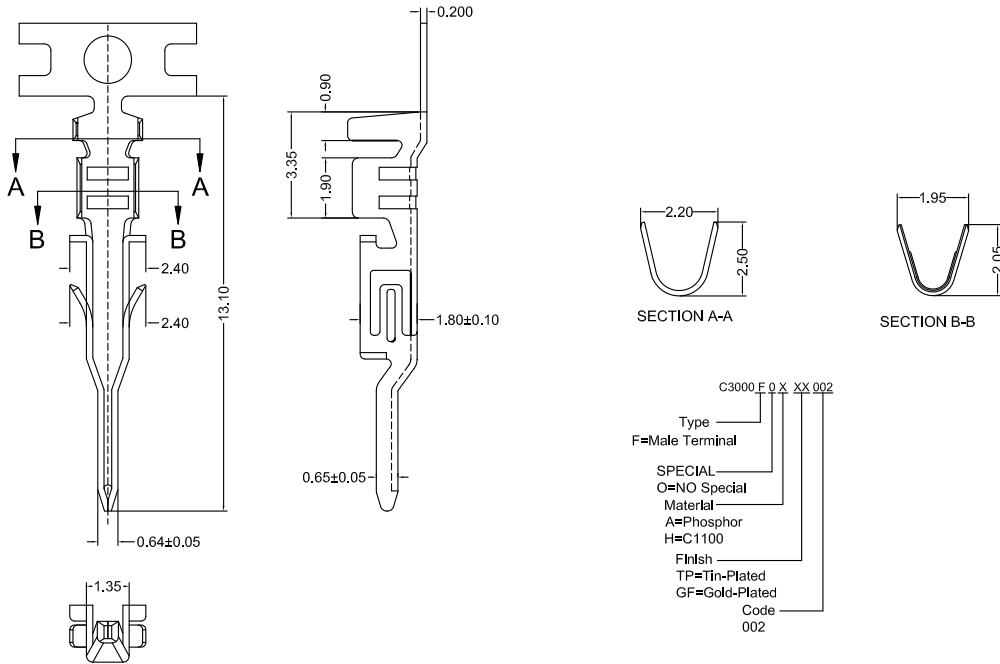

CSG PART NO.	Wire Range	Insulation O.D.	Q'ty/Reel
C3000FOXTP002	AWG#20~#24	1.85mm(max)	10000PCS
C3000FOXGF002	AWG#20~#24	1.85mm(max)	10000PCS

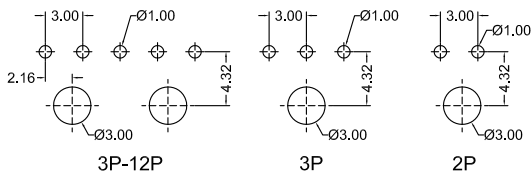
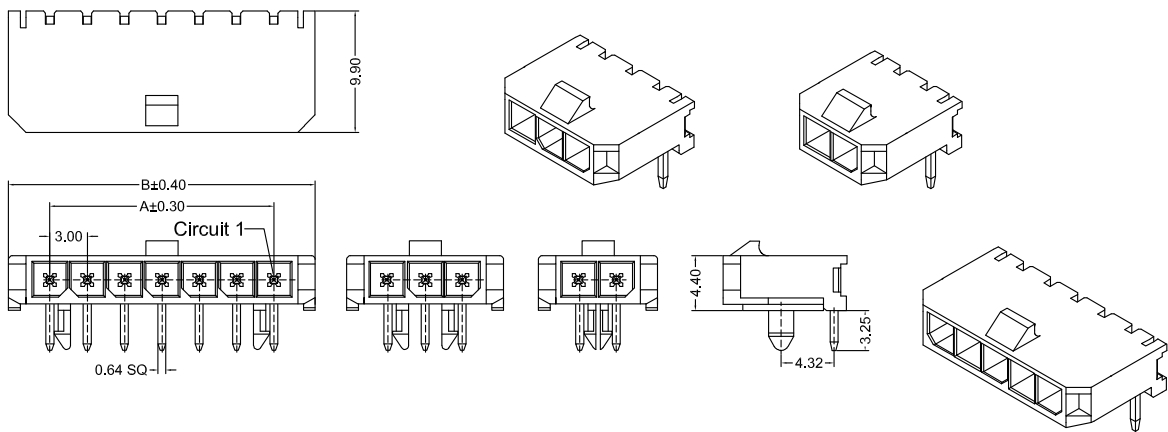

Recommended P.C.B Layout
General Tolerance±0.05

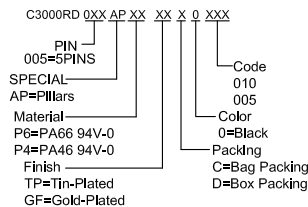

CSG PART NO.	Dimension mm		Q'ty
	A	B	
C3000RD002APXXXXX0XXX	3.00	9.65	1000PCS
C3000RD003APXXXXX0XXX	6.00	12.65	1000PCS
C3000RD004APXXXXX0XXX	9.00	15.65	1000PCS
C3000RD005APXXXXX0XXX	12.00	18.65	1000PCS
C3000RD006APXXXXX0XXX	15.00	21.65	1000PCS
C3000RD007APXXXXX0XXX	18.00	24.65	1000PCS
C3000RD008APXXXXX0XXX	21.00	27.65	1000PCS
C3000RD009APXXXXX0XXX	24.00	30.65	1000PCS
C3000RD010APXXXXX0XXX	27.00	33.65	1000PCS
C3000RD011APXXXXX0XXX	30.00	36.65	1000PCS
C3000RD012APXXXXX0XXX	33.00	39.65	1000PCS



C3000 MX 3.00

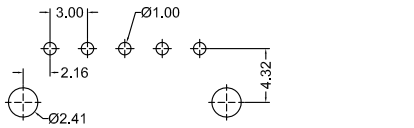
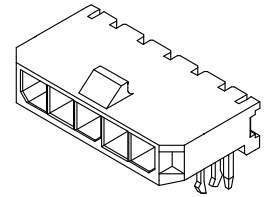
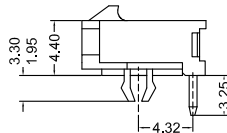
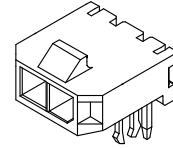
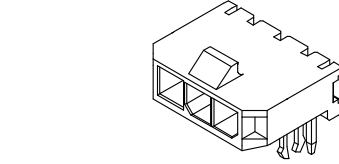
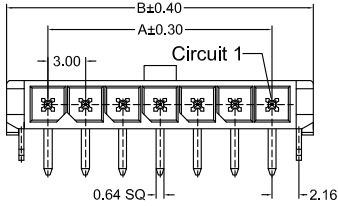
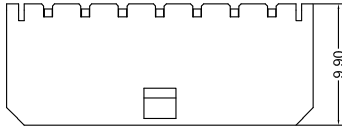

Recommended P.C.B Layout
General Tolerance±0.05

C3000RD 0XX AJ XX XX X 0 XXX

- PIN 005=5PINS
- SPECIAL
- AJ=Locator
- Material LP=LCP 94V-0 P6=PA66 94V-0
- Finish TP=Tin-Plated GF=Gold-Plated
- Code 001=3.30mm 002=1.95mm
- Color 0=Black
- Packing C=Bag Packing D=Box Packing

CSG PART NO.	Dimension mm		Q'ty
	A	B	
C3000RD002AJXXXXX0XXX	3.00	9.65	1000PCS
C3000RD003AJXXXXX0XXX	6.00	12.65	1000PCS
C3000RD004AJXXXXX0XXX	9.00	15.65	1000PCS
C3000RD005AJXXXXX0XXX	12.00	18.65	1000PCS
C3000RD006AJXXXXX0XXX	15.00	21.65	1000PCS
C3000RD007AJXXXXX0XXX	18.00	24.65	1000PCS
C3000RD008AJXXXXX0XXX	21.00	27.65	1000PCS
C3000RD009AJXXXXX0XXX	24.00	30.65	1000PCS
C3000RD010AJXXXXX0XXX	27.00	33.65	1000PCS
C3000RD011AJXXXXX0XXX	30.00	36.65	1000PCS
C3000RD012AJXXXXX0XXX	33.00	39.65	1000PCS

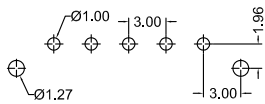
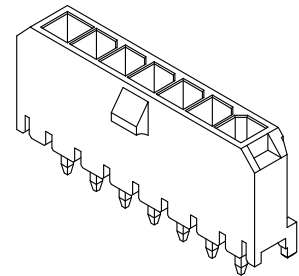
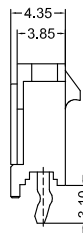
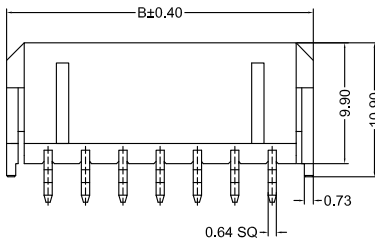
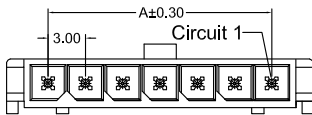

Recommended P.C.B Layout
General Tolerance±0.05

C3000VD 0XX PK XX XX C 0 010

- PIN 005=5PINS
- SPECIAL
- PK=Orientation K
- Material P6=PA66 94V-0 P4=PA46 94V-0
- Finish TP=Tin-Plated GF=Gold-Plated
- Code 010
- Color 0=Black
- Packing C=Bag Packing

CSG PART NO.	Dimension mm		Q'ty/BAG
	A	B	
C3000VD002PKXXXXC0010	3.00	9.65	1000PCS
C3000VD003PKXXXXC0010	6.00	12.65	1000PCS
C3000VD004PKXXXXC0010	9.00	15.65	1000PCS
C3000VD005PKXXXXC0010	12.00	18.65	1000PCS
C3000VD006PKXXXXC0010	15.00	21.65	1000PCS
C3000VD007PKXXXXC0010	18.00	24.65	1000PCS
C3000VD008PKXXXXC0010	21.00	27.65	1000PCS
C3000VD009PKXXXXC0010	24.00	30.65	1000PCS
C3000VD010PKXXXXC0010	27.00	33.65	1000PCS
C3000VD011PKXXXXC0010	30.00	36.65	1000PCS
C3000VD012PKXXXXC0010	33.00	39.65	1000PCS



C3000 MX 3.00

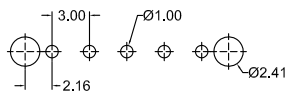
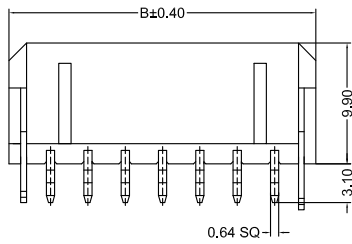
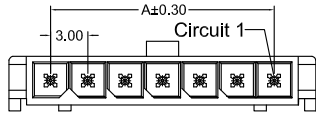

Recommended P.C.B Layout
General Tolerance±0.05

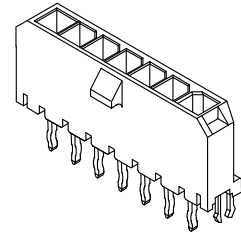
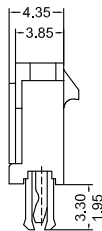

C3000VD 0XX AJ XX XX C 0 XXX
 PIN 005=5PINS
 SPECIAL AJ=Locator
 Material LP=LCP 94V-0
 P6=PA66 94V-0
 Finish TP=Tin-Plated
 GF=Gold-Plated
 Code 001=3.30mm
 002=1.95mm
 Color 0=Black
 Packing C=Bag Packing

CSG PART NO.	Dimension mm		Q'ty/BAG
	A	B	
C3000VD002AJXXXXC0XXX	3.00	9.65	1000PCS
C3000VD003AJXXXXC0XXX	6.00	12.65	1000PCS
C3000VD004AJXXXXC0XXX	9.00	15.65	1000PCS
C3000VD005AJXXXXC0XXX	12.00	18.65	1000PCS
C3000VD006AJXXXXC0XXX	15.00	21.65	1000PCS
C3000VD007AJXXXXC0XXX	18.00	24.65	1000PCS
C3000VD008AJXXXXC0XXX	21.00	27.65	1000PCS
C3000VD009AJXXXXC0XXX	24.00	30.65	1000PCS
C3000VD010AJXXXXC0XXX	27.00	33.65	1000PCS
C3000VD011AJXXXXC0XXX	30.00	36.65	1000PCS
C3000VD012AJXXXXC0XXX	33.00	39.65	1000PCS

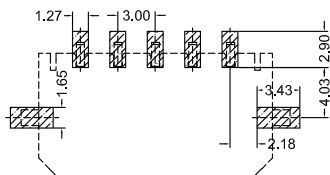
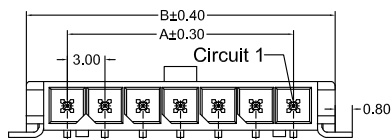

Recommended P.C.B Layout
General Tolerance±0.05

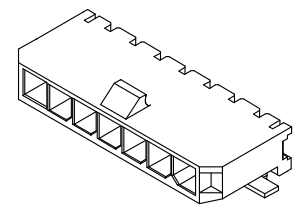
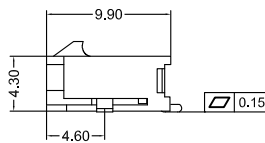

C3000RS 0XX AA LP XX B 0 001
 PIN 005=5PINS
 SPECIAL AA=NO Special
 Material LP=LCP 94V-0
 Finish TP=Tin-Plated
 GF=Gold-Plated
 Code 001
 Color 0=Black
 Packing B=Reel Packing

CSG PART NO.	Dimension mm		Q'ty/Reel
	A	B	
C3000RS002AALPXXB0001	3.00	9.65	500PCS
C3000RS003AALPXXB0001	6.00	12.65	500PCS
C3000RS004AALPXXB0001	9.00	15.65	500PCS
C3000RS005AALPXXB0001	12.00	18.65	500PCS
C3000RS006AALPXXB0001	15.00	21.65	500PCS
C3000RS007AALPXXB0001	18.00	24.65	500PCS
C3000RS008AALPXXB0001	21.00	27.65	500PCS
C3000RS009AALPXXB0001	24.00	30.65	500PCS
C3000RS010AALPXXB0001	27.00	33.65	500PCS
C3000RS011AALPXXB0001	30.00	36.65	500PCS
C3000RS012AALPXXB0001	33.00	39.65	500PCS



C3000 MX 3.00

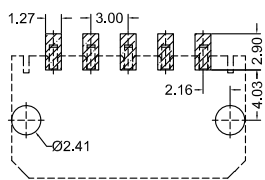
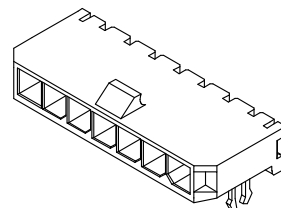
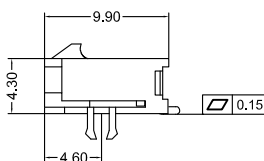
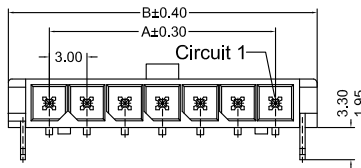
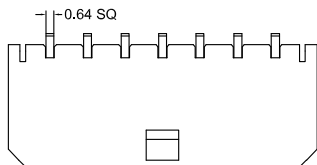

Recommended P.C.B Layout
General Tolerance±0.05

C3000RS 0XX AJ LP XX B 0 XXX
 PIN
 005=5PINS
 SPECIAL
 AJ=Locator
 Material
 LP=LCP 94V-0
 Finish
 TP=Tin-Plated
 GF=Gold-Plated
 Code
 001=3.30mm
 002=1.95mm
 Color
 0=Black
 Packing
 B=Reel Packing

CSG PART NO.	Dimension mm		Q'ty/Reel
	A	B	
C3000RS002AJLPXXB0XXX	3.00	9.65	500PCS
C3000RS003AJLPXXB0XXX	6.00	12.65	500PCS
C3000RS004AJLPXXB0XXX	9.00	15.65	500PCS
C3000RS005AJLPXXB0XXX	12.00	18.65	500PCS
C3000RS006AJLPXXB0XXX	15.00	21.65	500PCS
C3000RS007AJLPXXB0XXX	18.00	24.65	500PCS
C3000RS008AJLPXXB0XXX	21.00	27.65	500PCS
C3000RS009AJLPXXB0XXX	24.00	30.65	500PCS
C3000RS010AJLPXXB0XXX	27.00	33.65	500PCS
C3000RS011AJLPXXB0XXX	30.00	36.65	500PCS
C3000RS012AJLPXXB0XXX	33.00	39.65	500PCS

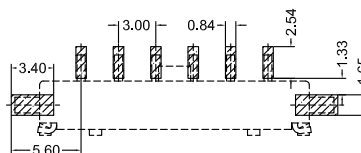
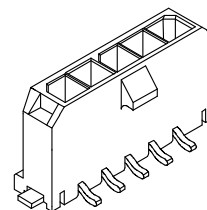
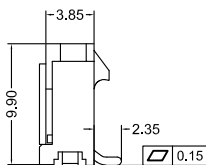
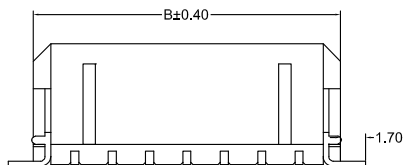
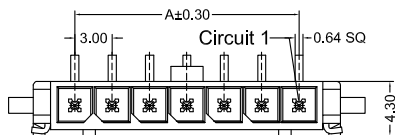

Recommended P.C.B Layout
General Tolerance±0.05

C3000VS 0XX AA LP XX B 0 001
 PIN
 005=5PINS
 SPECIAL
 AA=NO Special
 Material
 LP=LCP 94V-0
 Finish
 TP=Tin-Plated
 GF=Gold-Plated
 Code
 001
 Color
 0=Black
 Packing
 B=Reel Packing

CSG PART NO.	Dimension mm		Q'ty/Reel
	A	B	
C3000VS002AALPXXB0001	3.00	9.65	250PCS
C3000VS003AALPXXB0001	6.00	12.65	250PCS
C3000VS004AALPXXB0001	9.00	15.65	250PCS
C3000VS005AALPXXB0001	12.00	18.65	250PCS
C3000VS006AALPXXB0001	15.00	21.65	250PCS
C3000VS007AALPXXB0001	18.00	24.65	250PCS
C3000VS008AALPXXB0001	21.00	27.65	250PCS
C3000VS009AALPXXB0001	24.00	30.65	250PCS
C3000VS010AALPXXB0001	27.00	33.65	250PCS
C3000VS011AALPXXB0001	30.00	36.65	250PCS
C3000VS012AALPXXB0001	33.00	39.65	250PCS



C3000 MX 3.00

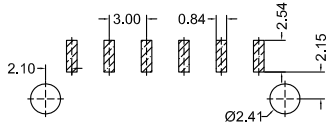
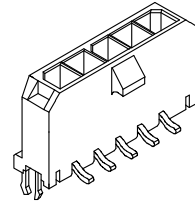
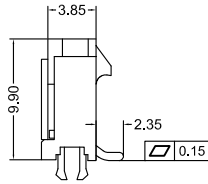
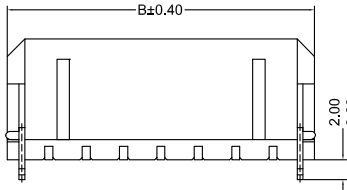
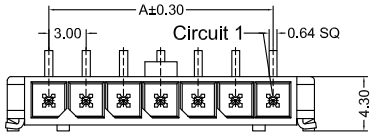

Recommended P.C.B Layout
General Tolerance±0.05

C3000VS 0XX AJ LP XX B 0 XXX
 PIN 005=5PINS
 SPECIAL AJ=Locator
 Material LP=LCP 94V-0
 Finish TP=Tin-Plated GF=Gold-Plated
 Code 001=3.60mm 002=2.00mm
 Color 0=Black
 Packing B=Reel Packing

CSG PART NO.	Dimension mm		Q'ty/Reel
	A	B	
C3000VS002AJLPXXB0XXX	3.00	9.65	250PCS
C3000VS003AJLPXXB0XXX	6.00	12.65	250PCS
C3000VS004AJLPXXB0XXX	9.00	15.65	250PCS
C3000VS005AJLPXXB0XXX	12.00	18.65	250PCS
C3000VS006AJLPXXB0XXX	15.00	21.65	250PCS
C3000VS007AJLPXXB0XXX	18.00	24.65	250PCS
C3000VS008AJLPXXB0XXX	21.00	27.65	250PCS
C3000VS009AJLPXXB0XXX	24.00	30.65	250PCS
C3000VS010AJLPXXB0XXX	27.00	33.65	250PCS
C3000VS011AJLPXXB0XXX	30.00	36.65	250PCS
C3000VS012AJLPXXB0XXX	33.00	39.65	250PCS

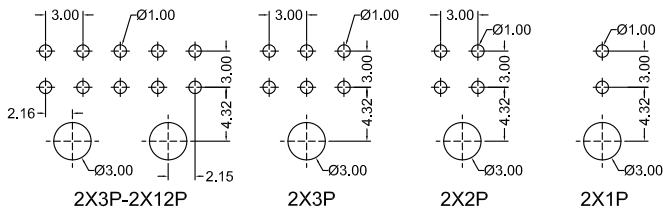
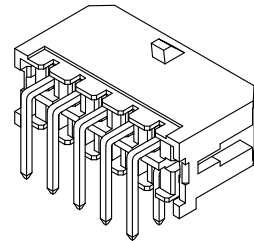
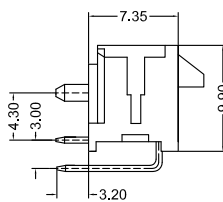
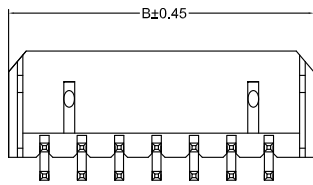
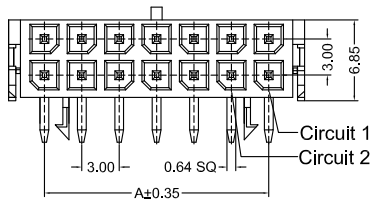

Recommended P.C.B Layout
General Tolerance±0.05

C3000RD 2XX AP XX XX X 0 XXX
 PIN 205=2X5PINS
 SPECIAL AP=Pillars
 Material P6=PA66 94V-0 P4=PA46 94V-0
 Finish TP=Tin-Plated GF=Gold-Plated
 Code 010 005
 Color 0=Black
 Packing C=Bag Packing D=Box Packing

CSG PART NO.	Dimension mm		Q'ty
	A	B	
C3000RD201APXXXXX0XXX	3.00	6.65	1000PCS
C3000RD202APXXXXX0XXX	6.00	9.65	1000PCS
C3000RD203APXXXXX0XXX	9.00	12.65	1000PCS
C3000RD204APXXXXX0XXX	12.00	15.65	1000PCS
C3000RD205APXXXXX0XXX	15.00	18.65	1000PCS
C3000RD206APXXXXX0XXX	18.00	21.65	1000PCS
C3000RD207APXXXXX0XXX	21.00	24.65	1000PCS
C3000RD208APXXXXX0XXX	24.00	27.65	1000PCS
C3000RD209APXXXXX0XXX	27.00	30.65	1000PCS
C3000RD210APXXXXX0XXX	30.00	33.65	1000PCS
C3000RD211APXXXXX0XXX	33.00	36.65	1000PCS
C3000RD212APXXXXX0XXX	36.00	39.65	1000PCS



C3000 MX 3.00

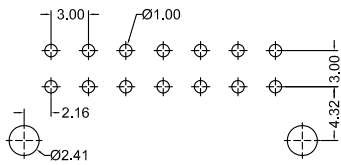
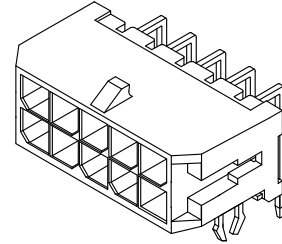
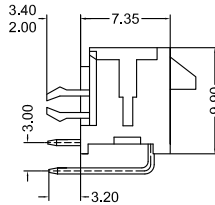
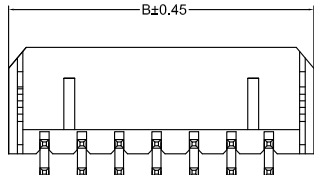
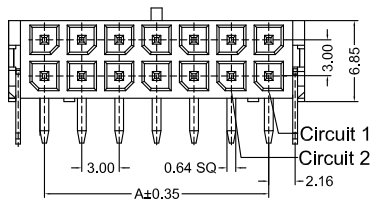

Recommended P.C.B Layout
General Tolerance±0.05

C3000RD 2XX AJ XX XX X 0 XXX
 PIN 205=2X5PINS
 SPECIAL AJ=Locator
 Material P6=PA66 94V-0
 LP=LCP 94V-0
 Finish TP=Tin-Plated
 GF=Gold-Plated
 Code 001=3.30mm
 002=1.95mm
 Color 0=Black
 Packing C=Bag Packing
 D=Box Packing

CSG PART NO.	Dimension mm		Q'ty
	A	B	
C3000RD201AJXXXXX0XXX		6.65	1000PCS
C3000RD202AJXXXXX0XXX	3.00	9.65	1000PCS
C3000RD203AJXXXXX0XXX	6.00	12.65	1000PCS
C3000RD204AJXXXXX0XXX	9.00	15.65	1000PCS
C3000RD205AJXXXXX0XXX	12.00	18.65	1000PCS
C3000RD206AJXXXXX0XXX	15.00	21.65	1000PCS
C3000RD207AJXXXXX0XXX	18.00	24.65	1000PCS
C3000RD208AJXXXXX0XXX	21.00	27.65	1000PCS
C3000RD209AJXXXXX0XXX	24.00	30.65	1000PCS
C3000RD210AJXXXXX0XXX	27.00	33.65	1000PCS
C3000RD211AJXXXXX0XXX	30.00	36.65	1000PCS
C3000RD212AJXXXXX0XXX	33.00	39.65	1000PCS

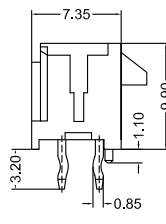
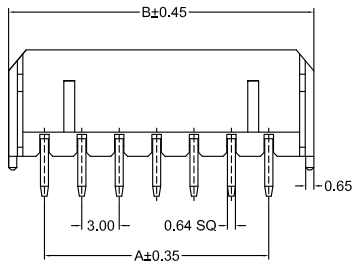
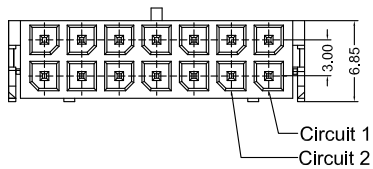

PK=Orientation K

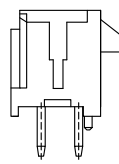

AP=NO Special

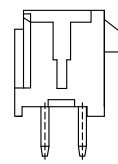

AA=NO Special

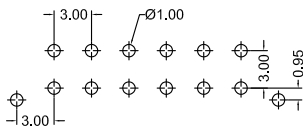
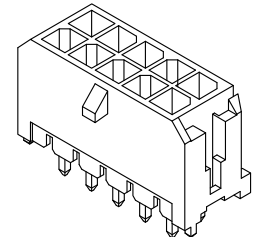

Recommended P.C.B Layout
General Tolerance±0.05

C3000VD 2XX XX XX XX C 0 XXX
 PIN 205=2X5PINS
 SPECIAL AA=NO Special
 PK=Orientation K
 AP=NO Special
 Material P6=PA66 94V-0
 P4=PA46 94V-0
 LP=LCP 94V-0
 Finish TP=Tin-Plated
 GF=Gold-Plated
 Code 010
 005
 Color 0=Black
 Packing C=Bag Packing

CSG PART NO.	Dimension mm		Q'ty
	A	B	
C3000VD201XXXXXC0XXX		6.65	1000PCS
C3000VD202XXXXXC0XXX	3.00	9.65	1000PCS
C3000VD203XXXXXC0XXX	6.00	12.65	1000PCS
C3000VD204XXXXXC0XXX	9.00	15.65	1000PCS
C3000VD205XXXXXC0XXX	12.00	18.65	1000PCS
C3000VD206XXXXXC0XXX	15.00	21.65	1000PCS
C3000VD207XXXXXC0XXX	18.00	24.65	1000PCS
C3000VD208XXXXXC0XXX	21.00	27.65	1000PCS
C3000VD209XXXXXC0XXX	24.00	30.65	1000PCS
C3000VD210XXXXXC0XXX	27.00	33.65	1000PCS
C3000VD211XXXXXC0XXX	30.00	36.65	1000PCS
C3000VD212XXXXXC0XXX	33.00	39.65	1000PCS



C3000 MX 3.00

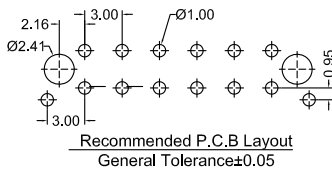
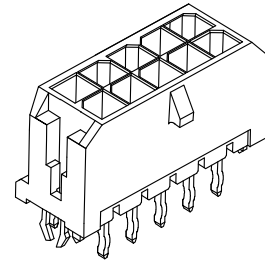
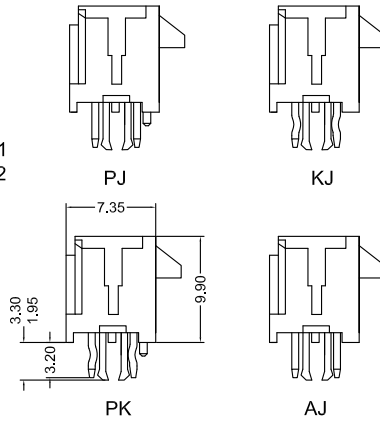
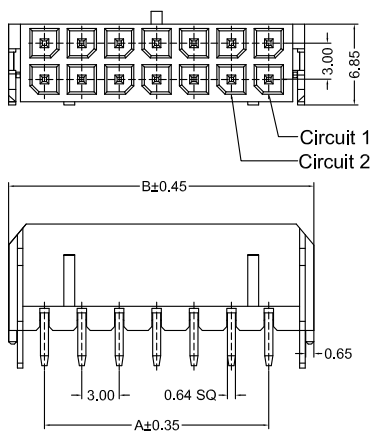

C3000VD 2XX XX XX XX C 0 XXX
 PIN 205=2X5PINS
 SPECIAL
 A=Locator
 PK=Orientallon K
 PJ=Pinllars and Locator
 KJ= K and Locator
 Material
 LP=LCP 94V-0
 P6=PA66 94V-0
 Finish
 TP=Tin-Plated
 GF=Gold-Plated

Code
 001=3.30mm
 002=1.95mm
 Color
 0=Black
 Packing
 C=Bag Packing

CSG PART NO.	Dimension mm		Q'ty/Reel
	A	B	
C3000VD201XXXXXXXXC0XXX	6.65	1000PCS	
C3000VD202XXXXXXXXC0XXX	3.00	9.65	1000PCS
C3000VD203XXXXXXXXC0XXX	6.00	12.65	1000PCS
C3000VD204XXXXXXXXC0XXX	9.00	15.65	1000PCS
C3000VD205XXXXXXXXC0XXX	12.00	18.65	1000PCS
C3000VD206XXXXXXXXC0XXX	15.00	21.65	1000PCS
C3000VD207XXXXXXXXC0XXX	18.00	24.65	1000PCS
C3000VD208XXXXXXXXC0XXX	21.00	27.65	1000PCS
C3000VD209XXXXXXXXC0XXX	24.00	30.65	1000PCS
C3000VD210XXXXXXXXC0XXX	27.00	33.65	1000PCS
C3000VD211XXXXXXXXC0XXX	30.00	36.65	1000PCS
C3000VD212XXXXXXXXC0XXX	33.00	39.65	1000PCS

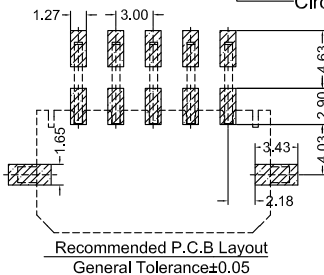
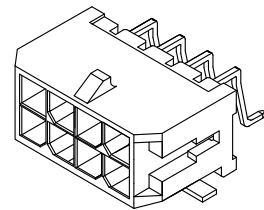
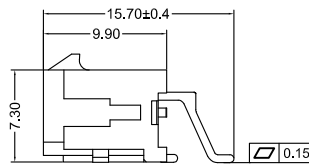
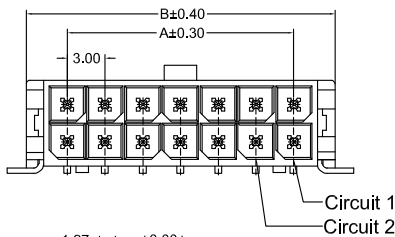
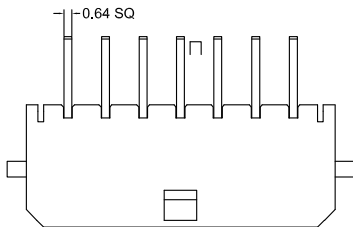

C3000RS 2XX AA LP XX B 0 001
 PIN 205=2X5PINS
 SPECIAL
 AA=NO Special
 Material
 LP=LCP 94V-0
 Finish
 TP=Tin-Plated
 GF=Gold-Plated

Code
 001
 Color
 0=Black
 Packing
 B=Reel Packing

CSG PART NO.	Dimension mm		Q'ty/Reel
	A	B	
C3000RS201AALPXXB0001	6.65	250PCS	
C3000RS202AALPXXB0001	3.00	9.65	250PCS
C3000RS203AALPXXB0001	6.00	12.65	250PCS
C3000RS204AALPXXB0001	9.00	15.65	250PCS
C3000RS205AALPXXB0001	12.00	18.65	250PCS
C3000RS206AALPXXB0001	15.00	21.65	250PCS
C3000RS207AALPXXB0001	18.00	24.65	250PCS
C3000RS208AALPXXB0001	21.00	27.65	250PCS
C3000RS209AALPXXB0001	24.00	30.65	250PCS
C3000RS210AALPXXB0001	27.00	33.65	250PCS
C3000RS211AALPXXB0001	30.00	36.65	250PCS
C3000RS212AALPXXB0001	33.00	39.65	250PCS



C3000 MX 3.00

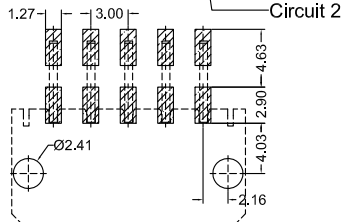
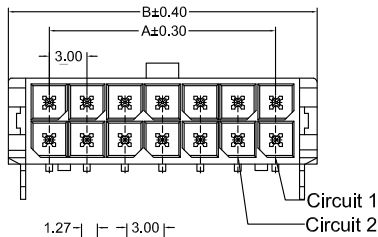
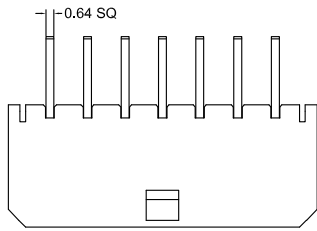

Recommended P.C.B Layout
General Tolerance±0.05

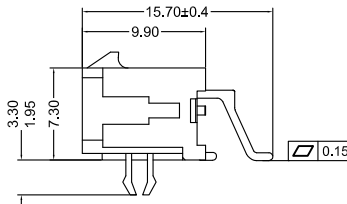

C3000RS 2XX AJ LP XX B 0 XXX
 PIN 205=2X5PINS
 SPECIAL AJ=Locator
 Material LP=LCP 94V-0
 Finish TP=Tin-Plated
 GF=Gold-Plated
 Code Code 001=3.30mm
 002=1.95mm
 Color 0=Black
 Packing B=Reel Packing

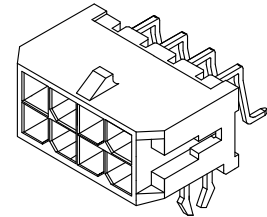

CSG PART NO.	Dimension mm		Q'ty/Reel
	A	B	
C3000RS201AJLPXXB0XXX	6.65	250PCS	250PCS
C3000RS202AJLPXXB0XXX	3.00	9.65	250PCS
C3000RS203AJLPXXB0XXX	6.00	12.65	250PCS
C3000RS204AJLPXXB0XXX	9.00	15.65	250PCS
C3000RS205AJLPXXB0XXX	12.00	18.65	250PCS
C3000RS206AJLPXXB0XXX	15.00	21.65	250PCS
C3000RS207AJLPXXB0XXX	18.00	24.65	250PCS
C3000RS208AJLPXXB0XXX	21.00	27.65	250PCS
C3000RS209AJLPXXB0XXX	24.00	30.65	250PCS
C3000RS210AJLPXXB0XXX	27.00	33.65	250PCS
C3000RS211AJLPXXB0XXX	30.00	36.65	250PCS
C3000RS212AJLPXXB0XXX	33.00	39.65	250PCS

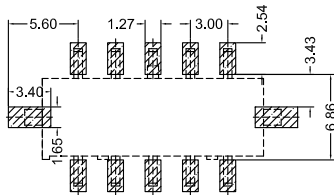
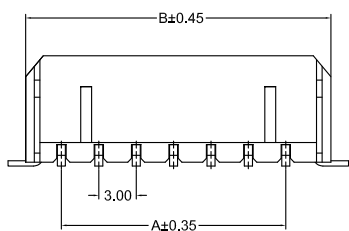
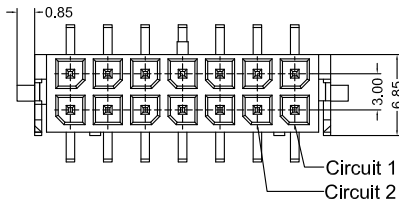

Recommended P.C.B Layout
General Tolerance±0.05

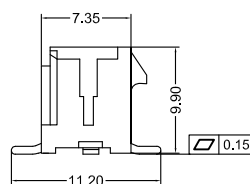

C3000VS 2XX AA LP XX B 0 001
 PIN 205=2X5PINS
 SPECIAL AA=NO Special
 Material LP=LCP 94V-0
 Finish TP=Tin-Plated
 GF=Gold-Plated
 Code 001
 Color 0=Black
 Packing B=Reel Packing

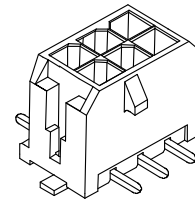

CSG PART NO.	Dimension mm		Q'ty/Reel
	A	B	
C3000VS201AALPXXB0001	6.65	250PCS	250PCS
C3000VS202AALPXXB0001	3.00	9.65	250PCS
C3000VS203AALPXXB0001	6.00	12.65	250PCS
C3000VS204AALPXXB0001	9.00	15.65	250PCS
C3000VS205AALPXXB0001	12.00	18.65	250PCS
C3000VS206AALPXXB0001	15.00	21.65	250PCS
C3000VS207AALPXXB0001	18.00	24.65	250PCS
C3000VS208AALPXXB0001	21.00	27.65	250PCS
C3000VS209AALPXXB0001	24.00	30.65	250PCS
C3000VS210AALPXXB0001	27.00	33.65	250PCS
C3000VS211AALPXXB0001	30.00	36.65	250PCS
C3000VS212AALPXXB0001	33.00	39.65	250PCS



C3000 MX 3.00

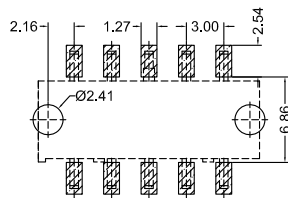
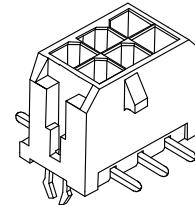
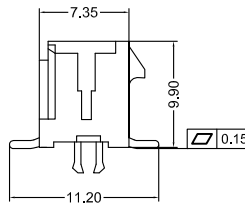
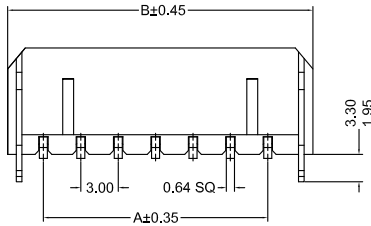
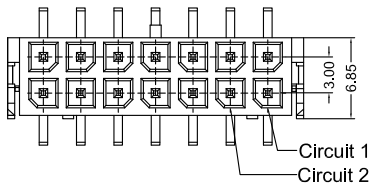

Recommended P.C.B Layout
General Tolerance±0.05

C3000VS 2XX AJ LP XX B 0 XXX

- PIN
- 205=2X5PINS
- SPECIAL
- AJ=Locator
- Material
- LP=LCP 94V-0
- Finish
- TP=TiN-Plated
- GF=Gold-Plated
- Code
- 001=3.30mm
- 002=1.95mm
- Color
- 0=Black
- Packing
- B=Reel Packing

CSG PART NO.	Dimension mm		Q'ty/Reel
	A	B	
C3000VS201AJLPXXB0XXX	6.65	250PCS	
C3000VS202AJLPXXB0XXX	3.00	9.65	250PCS
C3000VS203AJLPXXB0XXX	6.00	12.65	250PCS
C3000VS204AJLPXXB0XXX	9.00	15.65	250PCS
C3000VS205AJLPXXB0XXX	12.00	18.65	250PCS
C3000VS206AJLPXXB0XXX	15.00	21.65	250PCS
C3000VS207AJLPXXB0XXX	18.00	24.65	250PCS
C3000VS208AJLPXXB0XXX	21.00	27.65	250PCS
C3000VS209AJLPXXB0XXX	24.00	30.65	250PCS
C3000VS210AJLPXXB0XXX	27.00	33.65	250PCS
C3000VS211AJLPXXB0XXX	30.00	36.65	250PCS
C3000VS212AJLPXXB0XXX	33.00	39.65	250PCS