

A2505 XHB CONNECTOR

2.50mm Pitch/Disconnectable Crimp style connectors

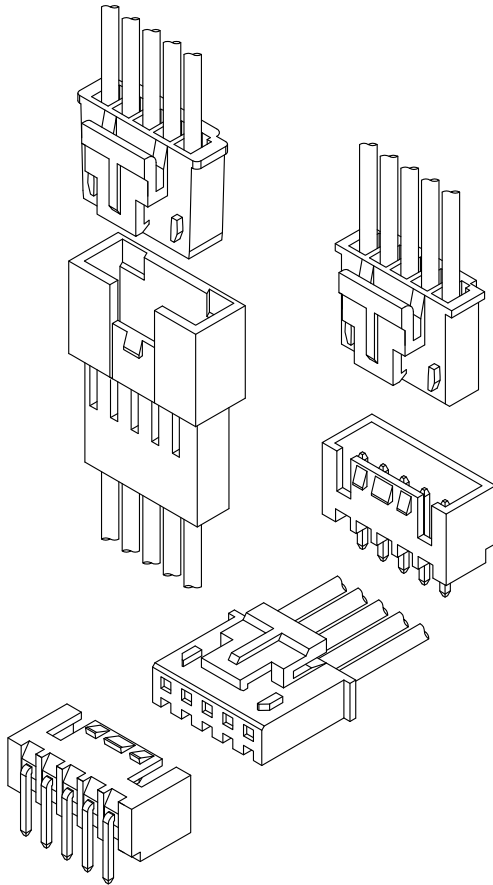

- Secure locking structure
- Low insertion force
- Suction area for picking up
- Improvement of engagement with prying

Specifications:

- Current rating: 2.5 A / AC,DC (AWG #22)
- Voltage rating: 250 V AC/DC
- Temperature range: -25°C ~ +105°C
(including temperature rise in applying electrical current)
- Contact resistance: Initial value/ 20m Ω max
Insulation resistance: 1000 MΩ min
Withstanding voltage: 1000 VAC/minute
Applicable wire: Conductor size/ AWG#28~#22
Insulation O.D./ 0.80 to 1.90 mm

- * Compliant with RoHS2/ REACH
- * Refer to "General Instruction and Notice when using Terminals and Connectors"
- * Contact CSG for details

Material:

Housing: PA66/UL94-V0;Color:White

Terminal: Phosphor/ Tin-plated

DIP Wafer Housing: PA66,UL94-V0;Color:White

DIP Wafer Pin: Brass/ Tin-plated

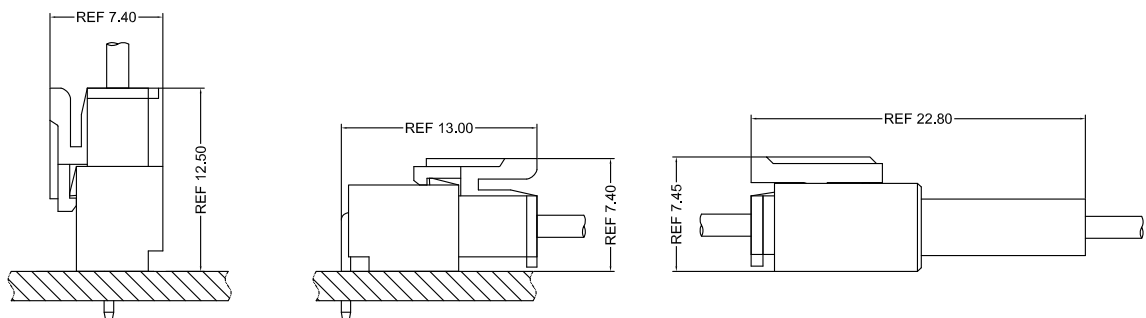

- Note: 1. The above figure is the figure viewed from the connector mounting side.
2. Tolerances are non-cumulative: ± 0.08 mm for all centers.
3. The dimensions above should serve as a guideline. Contact CSG for details.

CSG

A2505 XHB

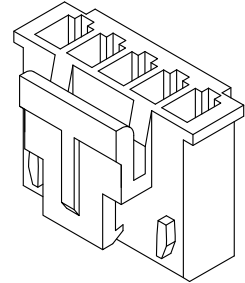
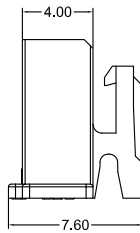
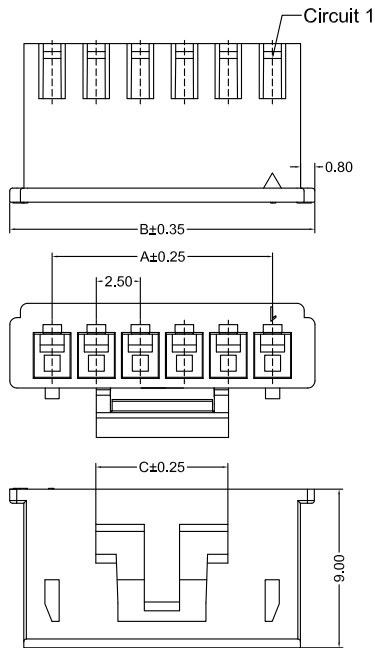

A2505HF 0XX AK P6 9 007
 PIN 005=5PINS
 SPECIAL: AK=BUCKLE
 Material P6=PA66 94V-0
 Code 007
 Color 9=White

CSG PART NO.	Dimension mm			Q'ty/BAG
	A	B	C	
A2505HF002AKP69007	2.50	5.70	3.00	1000PCS
A2505HF003AKP69007	5.00	8.20	4.00	1000PCS
A2505HF004AKP69007	7.50	10.70	5.00	1000PCS
A2505HF005AKP69007	10.00	13.20	7.50	1000PCS
A2505HF006AKP69007	12.50	15.70	10.00	1000PCS
A2505HF007AKP69007	15.00	18.20	12.50	1000PCS
A2505HF008AKP69007	17.50	20.70	12.50	1000PCS
A2505HF009AKP69007	20.00	23.20	12.50	1000PCS
A2505HF010AKP69007	22.50	25.70	12.50	1000PCS
A2505HF011AKP69007	25.00	28.20	12.50	1000PCS
A2505HF012AKP69007	27.50	30.70	12.50	1000PCS
A2505HF013AKP69007	30.00	33.20	12.50	1000PCS
A2505HF014AKP69007	32.50	35.70	12.50	1000PCS
A2505HF015AKP69007	35.00	38.20	12.50	1000PCS
A2505HF016AKP69007	37.50	40.70	12.50	1000PCS

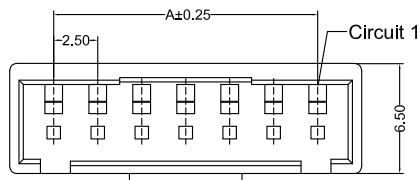
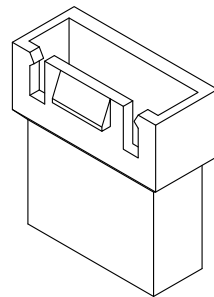
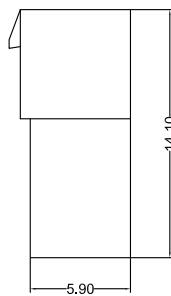
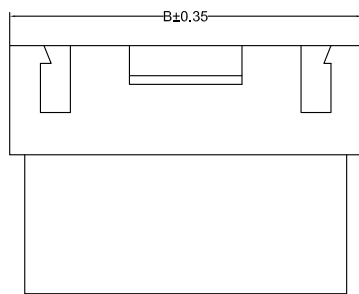

A2505HM 0XX AK P6 9 007
 PIN 005=5PINS
 SPECIAL: AA=NO Special
 Material P6=PA66 94V-0
 Code 007
 Color 9=White

CSG PART NO.	Dimension mm		Q'ty/BAG
	A	B	
A2505HM002AAP69007	2.50	7.50	1000PCS
A2505HM003AAP69007	5.00	10.00	1000PCS
A2505HM004AAP69007	7.50	12.50	1000PCS
A2505HM005AAP69007	10.00	15.00	1000PCS
A2505HM006AAP69007	12.50	17.50	1000PCS
A2505HM007AAP69007	15.00	20.00	1000PCS
A2505HM008AAP69007	17.50	22.50	1000PCS
A2505HM009AAP69007	20.00	25.00	1000PCS
A2505HM010AAP69007	22.50	27.50	1000PCS
A2505HM011AAP69007	25.00	30.00	1000PCS
A2505HM012AAP69007	27.50	32.50	1000PCS
A2505HM013AAP69007	30.00	35.00	1000PCS
A2505HM014AAP69007	32.50	37.50	1000PCS
A2505HM015AAP69007	35.00	40.00	1000PCS
A2505HM016AAP69007	37.50	42.50	1000PCS



A2505 XHB

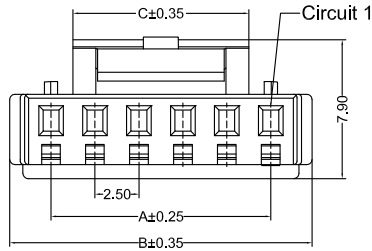
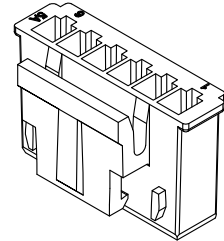
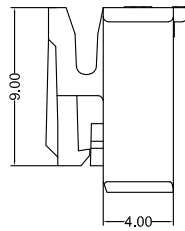
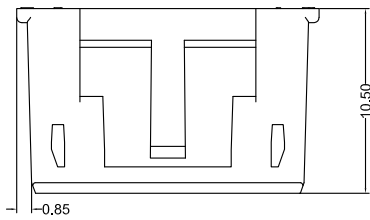

A2505HF 0XX AK P6 9 008
 PIN 005=5PINS
 SPECIAL AK=BUCKLE
 Material P6=PA66 94V-0
 Code 008
 Color 9=White

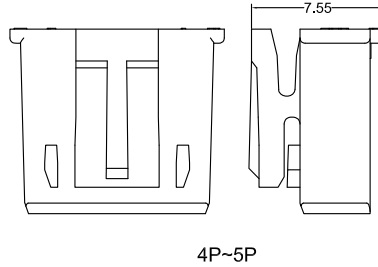
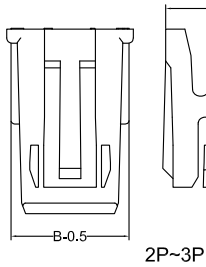

CSG PART NO.	Dimension mm			Q'ty/BAG
	A	B	C	
A2505HF002AKP69008	2.50	7.20	3.00	1000PCS
A2505HF003AKP69008	5.00	9.70	3.00	1000PCS
A2505HF004AKP69008	7.50	12.20	4.80	1000PCS
A2505HF005AKP69008	10.00	14.70	4.80	1000PCS
A2505HF006AKP69008	12.50	17.20	10.00	1000PCS
A2505HF007AKP69008	15.00	19.70	10.00	1000PCS
A2505HF008AKP69008	17.50	21.20	12.50	1000PCS
A2505HF009AKP69008	20.00	24.70	12.50	1000PCS
A2505HF010AKP69008	22.50	27.20	15.00	1000PCS
A2505HF011AKP69008	25.00	29.70	15.00	1000PCS
A2505HF012AKP69008	27.50	31.20	17.50	1000PCS
A2505HF013AKP69008	30.00	34.70	17.50	1000PCS
A2505HF014AKP69008	32.50	37.20	17.50	1000PCS
A2505HF015AKP69008	35.00	39.70	17.50	1000PCS

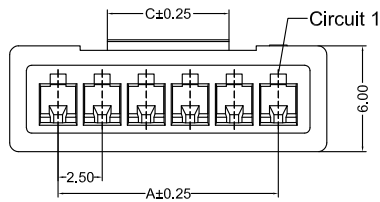
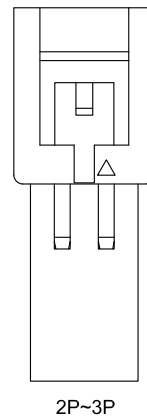
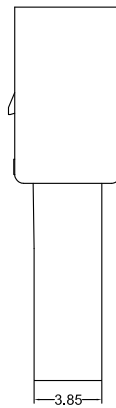
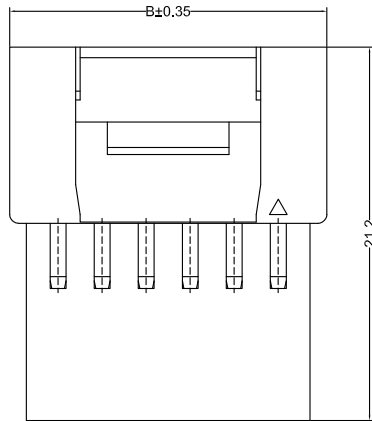

A2505HM 0XX AK P6 9 008
 PIN 005=5PINS
 SPECIAL AA=NO Special
 Material P6=PA66 94V-0
 Code 008
 Color 9=White

CSG PART NO.	Dimension mm			Q'ty/BAG
	A	B	C	
A2505HM002AAP69008	2.50	8.00	1.00	1000PCS
A2505HM003AAP69008	5.00	10.50	1.00	1000PCS
A2505HM004AAP69008	7.50	13.00	1.90	1000PCS
A2505HM005AAP69008	10.00	15.50	1.90	1000PCS
A2505HM006AAP69008	12.50	18.00	6.90	1000PCS
A2505HM007AAP69008	15.00	20.50	9.40	1000PCS
A2505HM008AAP69008	17.50	23.00	11.90	1000PCS
A2505HM009AAP69008	20.00	25.50	14.40	1000PCS
A2505HM010AAP69008	22.50	28.00	16.90	1000PCS
A2505HM011AAP69008	25.00	30.50	19.40	1000PCS
A2505HM012AAP69008	27.50	33.00	21.90	1000PCS
A2505HM013AAP69008	30.00	35.50	24.40	1000PCS
A2505HM014AAP69008	32.50	38.00	26.90	1000PCS
A2505HM015AAP69008	35.00	40.50	29.40	1000PCS



A2505 XHB

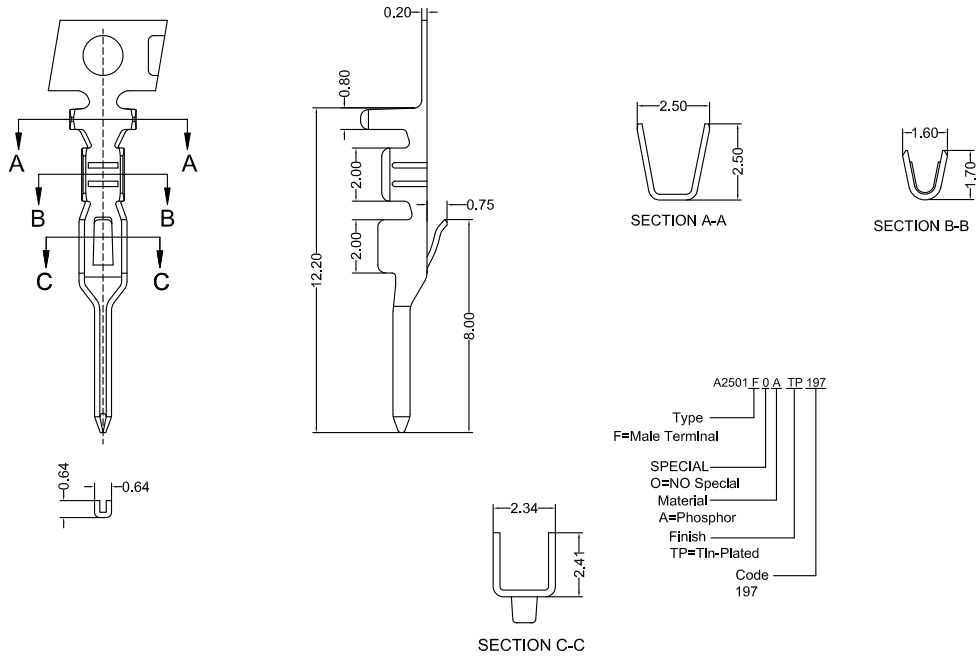

CSG PART NO.	Wire Range	Insulation O.D.	Q'ty/Reel
A2501F0ATP197	AWG#22-#28	1.80mm(max)	8000PCS

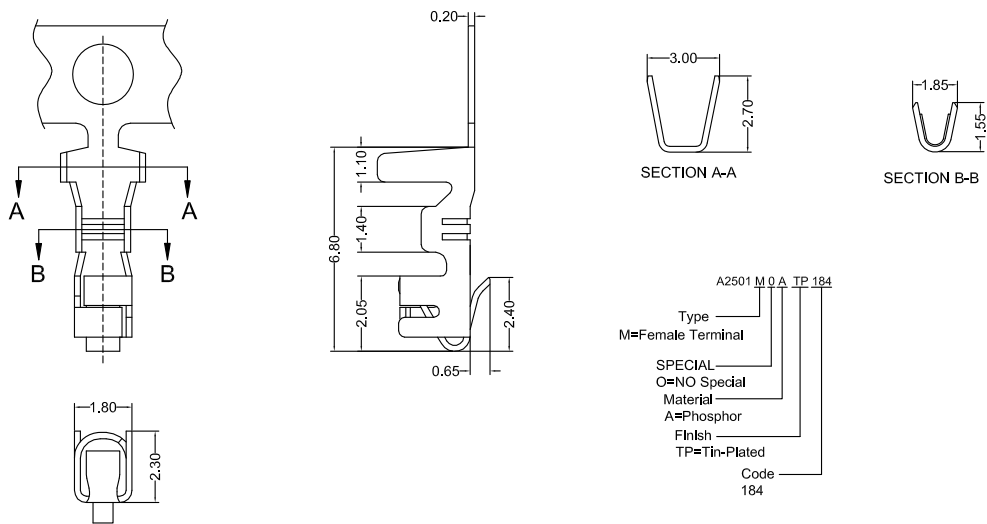

CSG PART NO.	Wire Range	Insulation O.D.	Q'ty/Reel
A2501M0ATP184	AWG#22-#28	1.80mm(max)	8000PCS



A2505 XHB

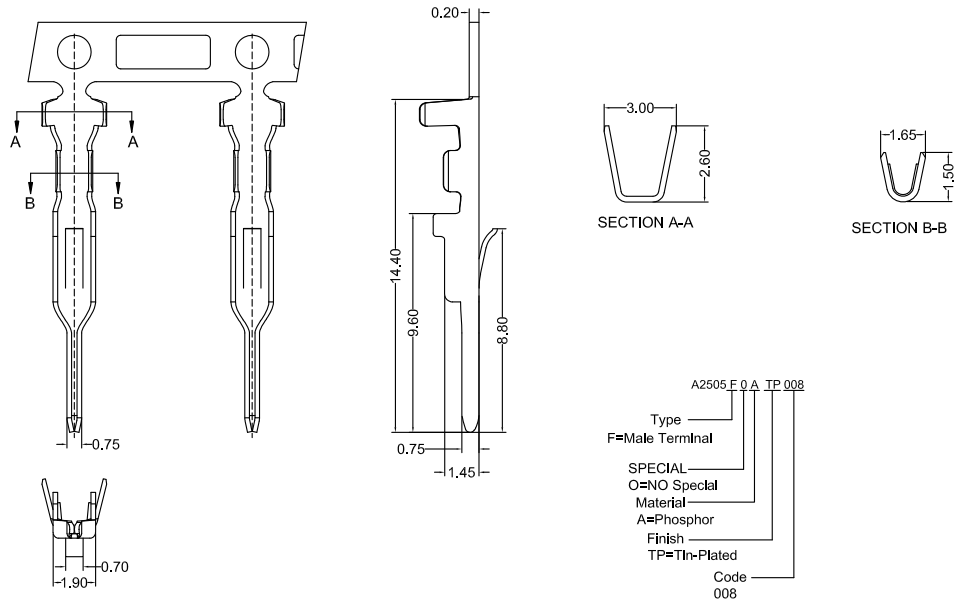

CSG PART NO.	Wire Range	Insulation O.D.	Q'ty/Reel
A2505F0ATP008	AWG#22-#28	1.90mm(max)	9000PCS

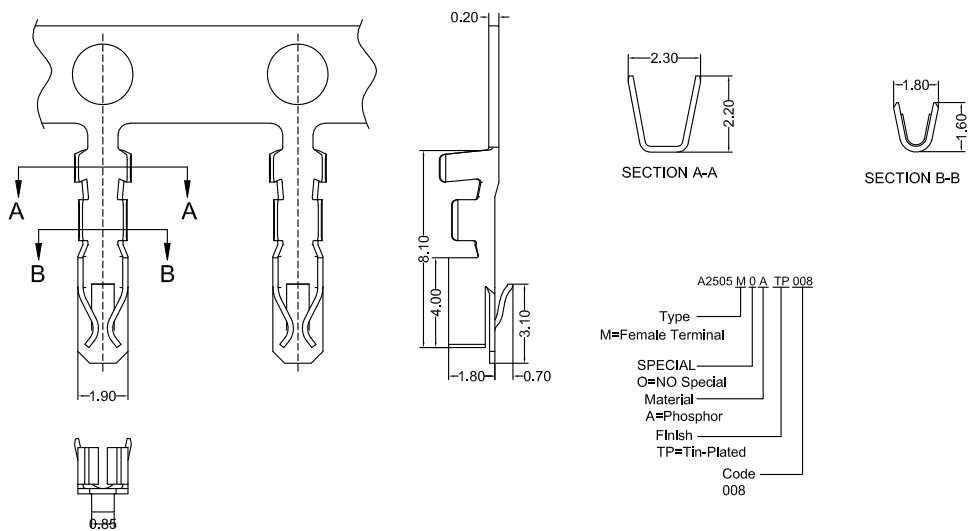

CSG PART NO.	Wire Range	Insulation O.D.	Q'ty/Reel
A2505M0ATP008	AWG#22-#28	1.90mm(max)	11000PCS



A2505 XHB

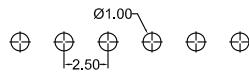
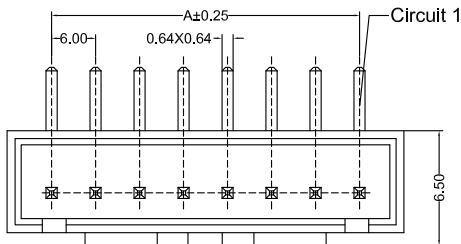
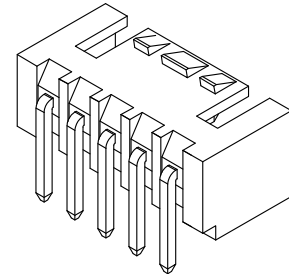
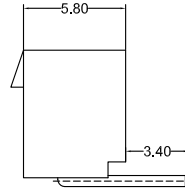
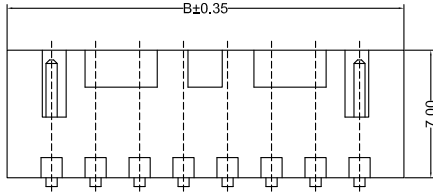

Recommended P.C.B Layout
General Tolerance±0.05

A2505RD_0XX AA P6 TP C 9 008
 PIN 002=2PINS
 SPECIAL
 AA=NO Special
 Material P6=PA66 94V-0
 Finish TP=Terminal Tin-Plated
 Code 008
 Color 9=White
 Packing C=Bag

CSG PART NO.	Dimension mm		Qty/BAG
	A	B	
A2505RD002AAP6TPC9008	2.50	7.50	1000PCS
A2505RD003AAP6TPC9008	5.00	10.00	1000PCS
A2505RD004AAP6TPC9008	7.50	12.50	1000PCS
A2505RD005AAP6TPC9008	10.00	15.00	1000PCS
A2505RD006AAP6TPC9008	12.50	17.50	1000PCS
A2505RD007AAP6TPC9008	15.00	20.00	1000PCS
A2505RD008AAP6TPC9008	17.50	22.50	1000PCS
A2505RD009AAP6TPC9008	20.00	25.00	1000PCS
A2505RD010AAP6TPC9008	22.50	27.50	1000PCS
A2505RD011AAP6TPC9008	25.00	30.00	1000PCS
A2505RD012AAP6TPC9008	27.50	32.50	1000PCS
A2505RD013AAP6TPC9008	30.00	35.00	1000PCS
A2505RD014AAP6TPC9008	32.50	37.50	1000PCS
A2505RD015AAP6TPC9008	35.00	40.00	1000PCS

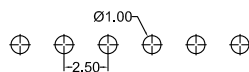
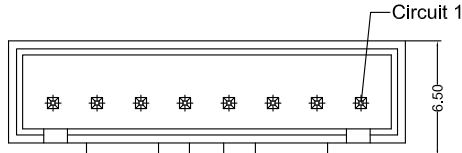
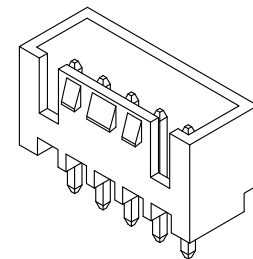
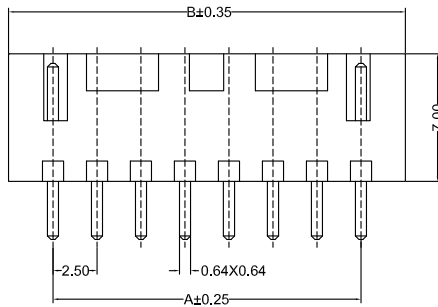

Recommended P.C.B Layout
General Tolerance±0.05

A2504VD_0XX AA P6 TP C X 007
 PIN 002=2PINS
 SPECIAL
 AA=NO Special
 Material P6=PA66 94V-0
 Finish TP=Terminal Tin-Plated
 Code 007
 Color 9=White
 Packing C=Belge
 C=Bag

CSG PART NO.	Dimension mm		Qty/BAG
	A	B	
A2504VD002AAP6TPCX007	2.50	7.50	1000PCS
A2504VD003AAP6TPCX007	5.00	10.00	1000PCS
A2504VD004AAP6TPCX007	7.50	12.50	1000PCS
A2504VD005AAP6TPCX007	10.00	15.00	1000PCS
A2504VD006AAP6TPCX007	12.50	17.50	1000PCS
A2504VD007AAP6TPCX007	15.00	20.00	1000PCS
A2504VD008AAP6TPCX007	17.50	22.50	1000PCS
A2504VD009AAP6TPCX007	20.00	25.00	1000PCS
A2504VD010AAP6TPCX007	22.50	27.50	1000PCS
A2504VD011AAP6TPCX007	25.00	30.00	1000PCS
A2504VD012AAP6TPCX007	27.50	32.50	1000PCS
A2504VD013AAP6TPCX007	30.00	35.00	1000PCS
A2504VD014AAP6TPCX007	32.50	37.50	1000PCS
A2504VD015AAP6TPCX007	35.00	40.00	1000PCS

