

A2013 PA CONNECTOR

2.00mm Pitch/Disconnectable Crimp style connectors

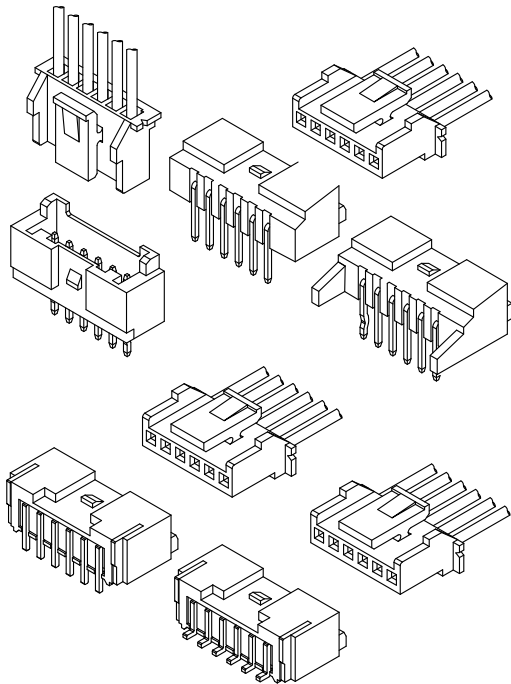

CSG E529482

- Secure locking structure
- Low insertion force
- Suction area for picking up
- Improvement of engagement with prying

Specifications:

- Current rating: 3.0 A / AC,DC (AWG #22)
- Voltage rating: 250 V AC/DC
- Temperature range: -25°C ~ +105°C
(including temperature rise in applying electrical current)
- Contact resistance: Initial value/ 30m Ω max
Insulation resistance: 1000 M Ω min
Withstanding voltage: 1000 VAC/minute
Applicable wire: Conductor size/ AWG#28~#22
Insulation O.D./ 0.80 to 1.50 mm
- * Compliant with RoHS2/ HF/ REACH
- * Refer to "General Instruction and Notice when using Terminals and Connectors"
- * Contact CSG for details

Material:

Housing: PA66 UL94-V0;Color:White

Terminal: Phosphor/ Tin-plated

DIP Wafer Housing: PA66,UL94-V0;Color:White

DIP Wafer Pin: Brass/ Tin-plated

SMT Wafer Housing: PA6T,UL94-V0;Color:Natural

SMT Wafer Pin: Brass/ Tin-plated

SMT Wafer Fixed Foot: Brass/ Tin-plated

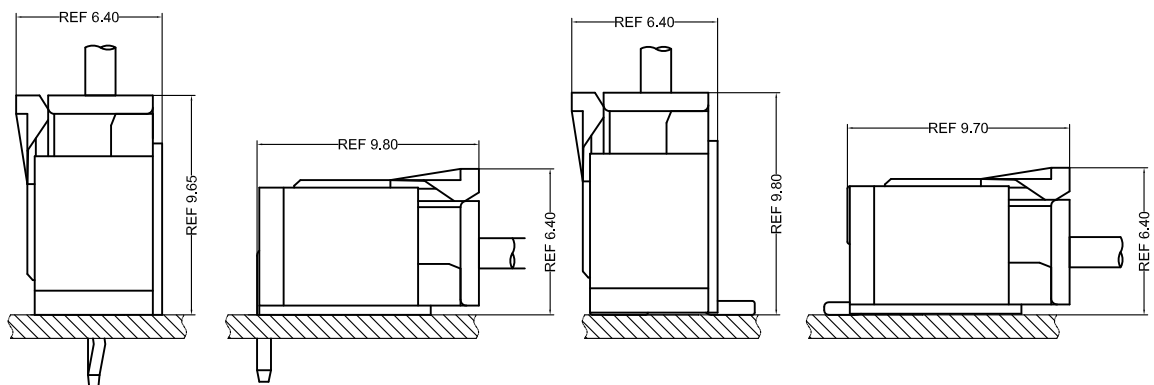

- Note: 1. The above figure is the figure viewed from the connector mounting side.
2. Tolerances are non-cumulative: ± 0.08 mm for all centers.
3. The dimensions above should serve as a guideline. Contact CSG for details.

CSG

A2013 PA

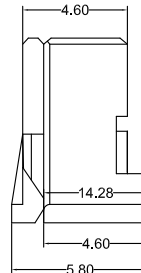
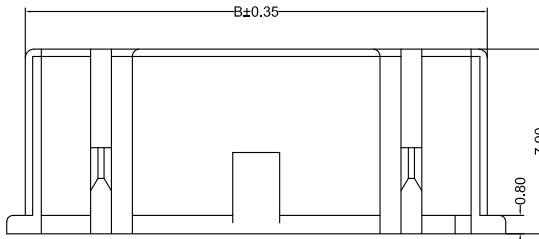
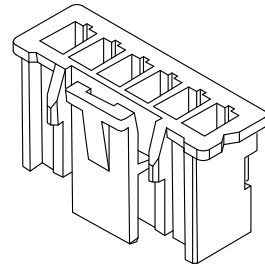
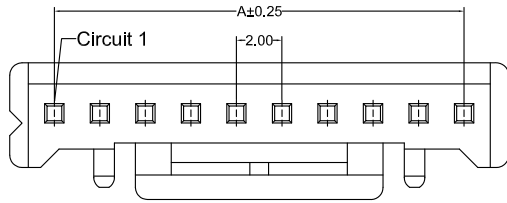

A2013HF 0XX AK P6 9 005
 PIN
 005=5PINS
 SPECIAL
 AK=BUCKLE
 Material
 P6=PA66 94V-0
 Code
 005
 Color
 9=White

CSG PART NO.	Dimension mm		Qty/BAG
	A	B	
A2013HF002AKP69005	2.00	4.30	1000PCS
A2013HF003AKP69005	4.00	6.30	1000PCS
A2013HF004AKP69005	6.00	8.30	1000PCS
A2013HF005AKP69005	8.00	10.30	1000PCS
A2013HF006AKP69005	10.00	12.30	1000PCS
A2013HF007AKP69005	12.00	14.30	1000PCS
A2013HF008AKP69005	14.00	16.30	1000PCS
A2013HF009AKP69005	16.00	18.30	1000PCS
A2013HF010AKP69005	18.00	20.30	1000PCS
A2013HF011AKP69005	20.00	22.30	1000PCS
A2013HF012AKP69005	22.00	24.30	1000PCS
A2013HF013AKP69005	24.00	26.30	1000PCS
A2013HF014AKP69005	26.00	28.30	1000PCS
A2013HF015AKP69005	28.00	30.30	1000PCS

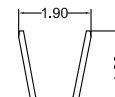
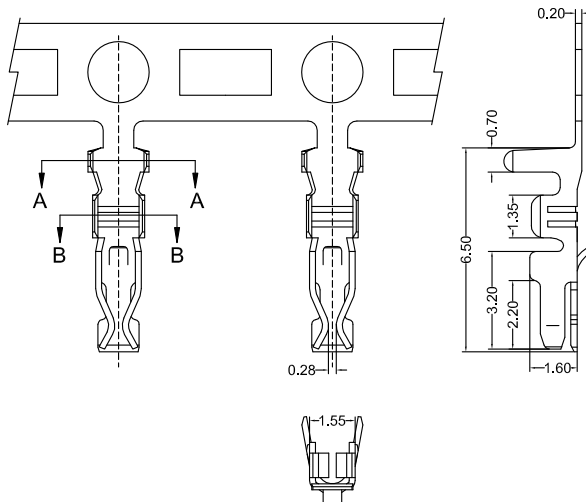

A2004 M O A TP 002
 Type
 M=Female Terminal
 SPECIAL
 O=NO Special
 Material
 A=Phosphor
 Finish
 TP=Tin-Plated
 Code
 002

CSG PART NO.	Wire Range	Insulation O.D.	Qty/Reel
A2004M0ATP002	AWG#22-#28	1.50mm(max)	12000PCS



A2013 PA

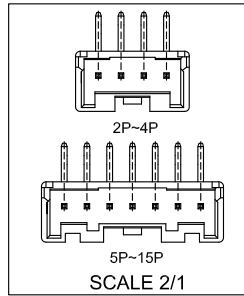
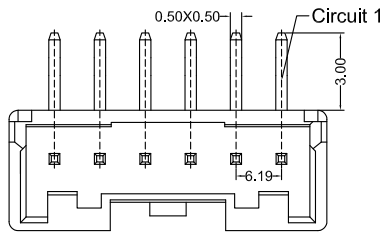
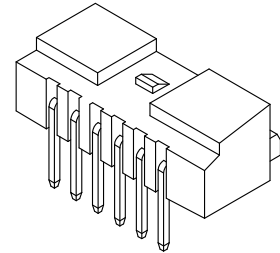
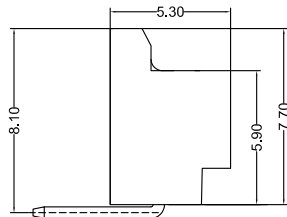
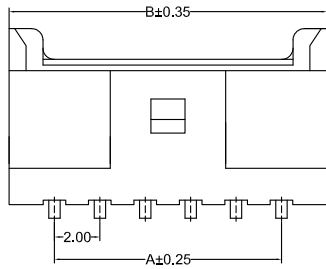

Recommended P.C.B Layout
General Tolerance±0.05

A2013RD.0XX AA P6 TP C 9 008
 PIN 002=2PINS
 SPECIAL AA=NO Special
 Material P6=PA66 94V-0
 Finish TP=Terminal Tin-Plated
 Code 008
 Color 9=White
 Packing C=Bag

CSG PART NO.	Dimension mm		Qty/BAG
	A	B	
A2013RD002AAP6TPC9008	2.00	6.00	1000PCS
A2013RD003AAP6TPC9008	4.00	8.00	1000PCS
A2013RD004AAP6TPC9008	6.00	10.00	1000PCS
A2013RD005AAP6TPC9008	8.00	12.00	1000PCS
A2013RD006AAP6TPC9008	10.00	14.00	1000PCS
A2013RD007AAP6TPC9008	12.00	16.00	1000PCS
A2013RD008AAP6TPC9008	14.00	18.00	1000PCS
A2013RD009AAP6TPC9008	16.00	20.00	1000PCS
A2013RD010AAP6TPC9008	18.00	22.00	1000PCS
A2013RD011AAP6TPC9008	20.00	24.00	1000PCS
A2013RD012AAP6TPC9008	22.00	26.00	1000PCS
A2013RD013AAP6TPC9008	24.00	28.00	1000PCS
A2013RD014AAP6TPC9008	26.00	30.00	1000PCS
A2013RD015AAP6TPC9008	28.00	32.00	1000PCS

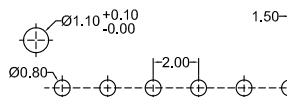
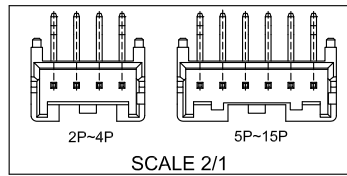
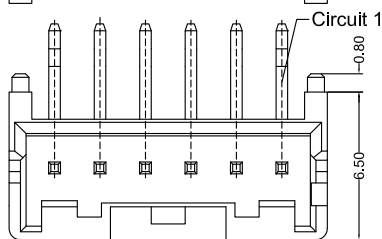
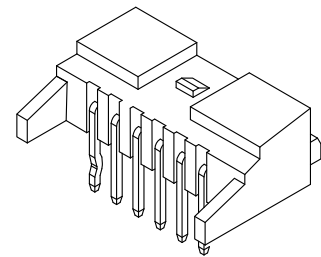
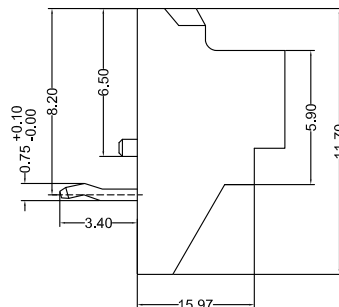
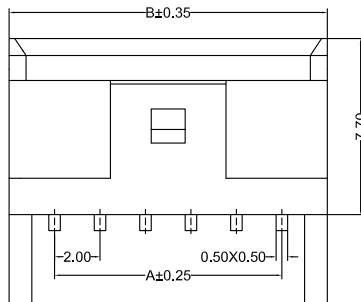

Recommended P.C.B Layout
General Tolerance±0.05

A2013RD.0XX PK P6 TP C 9 008
 PIN 002=2PINS
 SPECIAL PK=Orientation K
 Material P6=PA66 94V-0
 Finish TP=Terminal Tin-Plated
 Code 008
 Color 9=White
 Packing C=Bag

CSG PART NO.	Dimension mm		Qty/BAG
	A	B	
A2013RD002PKP6TPC9008	2.00	6.00	1000PCS
A2013RD003PKP6TPC9008	4.00	8.00	1000PCS
A2013RD004PKP6TPC9008	6.00	10.00	1000PCS
A2013RD005PKP6TPC9008	8.00	12.00	1000PCS
A2013RD006PKP6TPC9008	10.00	14.00	1000PCS
A2013RD007PKP6TPC9008	12.00	16.00	1000PCS
A2013RD008PKP6TPC9008	14.00	18.00	1000PCS
A2013RD009PKP6TPC9008	16.00	20.00	1000PCS
A2013RD010PKP6TPC9008	18.00	22.00	1000PCS
A2013RD011PKP6TPC9008	20.00	24.00	1000PCS
A2013RD012PKP6TPC9008	22.00	26.00	1000PCS
A2013RD013PKP6TPC9008	24.00	28.00	1000PCS
A2013RD014PKP6TPC9008	26.00	30.00	1000PCS
A2013RD015AAP6TPC9008	28.00	32.00	1000PCS



A2013 PA

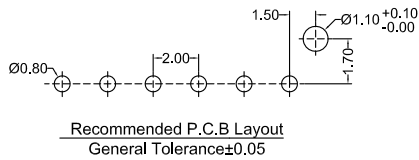
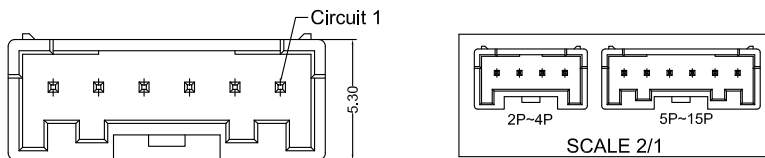
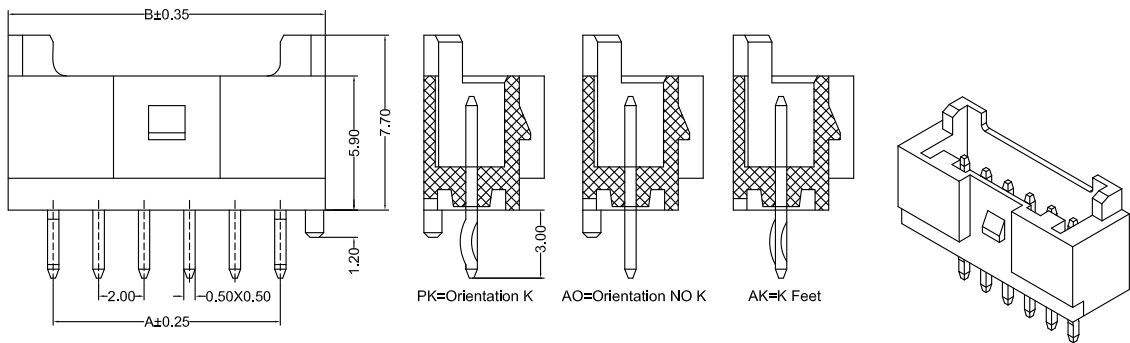

A2013VD.0XX XX P6 TP C 9 008

PIN 002=2PINS

SPECIAL AK=K Feet AO=Orientation NO K PK=Orientation K

Material P6=PA66 94V-0

Finish TP=Terminal Tin-Plated

Code 008

Color 9=White

Packing C=Bag

CSG PART NO.	Dimension mm		Qty/BAG
	A	B	
A2013VD002XXP6TPC9008	2.00	6.00	1000PCS
A2013VD003XXP6TPC9008	4.00	8.00	1000PCS
A2013VD004XXP6TPC9008	6.00	10.00	1000PCS
A2013VD005XXP6TPC9008	8.00	12.00	1000PCS
A2013VD006XXP6TPC9008	10.00	14.00	1000PCS
A2013VD007XXP6TPC9008	12.00	16.00	1000PCS
A2013VD008XXP6TPC9008	14.00	18.00	1000PCS
A2013VD009XXP6TPC9008	16.00	20.00	1000PCS
A2013VD010XXP6TPC9008	18.00	22.00	1000PCS
A2013VD011XXP6TPC9008	20.00	24.00	1000PCS
A2013VD012XXP6TPC9008	22.00	26.00	1000PCS
A2013VD013XXP6TPC9008	24.00	28.00	1000PCS
A2013VD014XXP6TPC9008	26.00	30.00	1000PCS
A2013VD015XXP6TPC9008	28.00	32.00	1000PCS

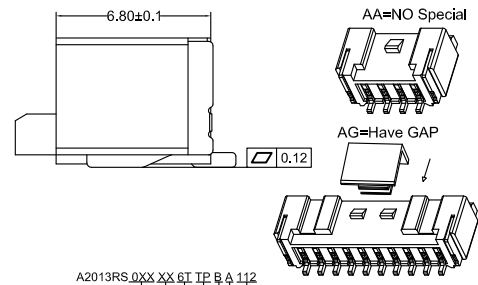
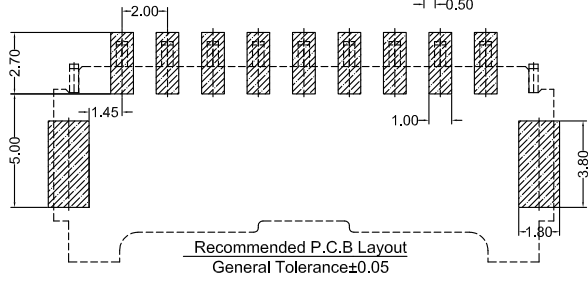
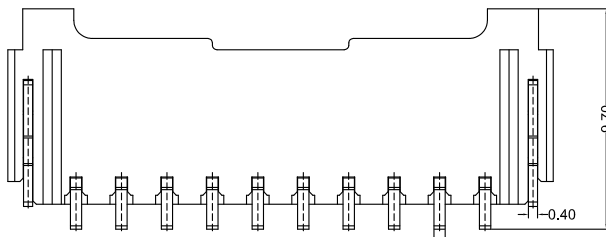
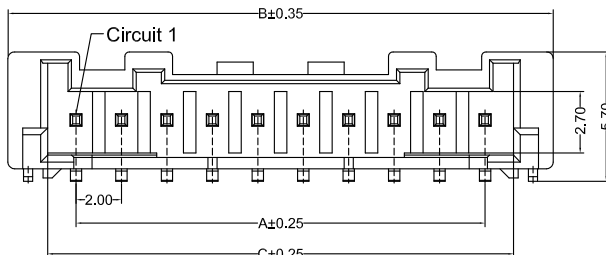

A2013RS.0XX XX 6T TP B A 112

PIN 002=2PINS

SPECIAL AA=NO Special AG=Have GAP

Material 6T=PA6T 94V-0

Finish TP=Terminal Tin-Plated

Code 112

Color A=Natural

Packing B=Reel Packing

CSG PART NO.	Dimension mm			Qty/Reel
	A	B	C	
A2013RS002XX6TTPBA112	2.00	8.00	4.55	700PCS
A2013RS003XX6TTPBA112	4.00	10.00	6.55	700PCS
A2013RS004XX6TTPBA112	6.00	12.00	8.55	700PCS
A2013RS005XX6TTPBA112	8.00	14.00	10.55	700PCS
A2013RS006XX6TTPBA112	10.00	16.00	12.55	700PCS
A2013RS007XX6TTPBA112	12.00	18.00	14.55	700PCS
A2013RS008XX6TTPBA112	14.00	20.00	16.55	700PCS
A2013RS009XX6TTPBA112	16.00	22.00	18.55	700PCS
A2013RS010XX6TTPBA112	18.00	24.00	20.55	700PCS
A2013RS011XX6TTPBA112	20.00	26.00	22.55	700PCS
A2013RS012XX6TTPBA112	22.00	28.00	24.55	700PCS
A2013RS013XX6TTPBA112	24.00	30.00	26.55	700PCS
A2013RS014XX6TTPBA112	26.00	32.00	28.55	700PCS
A2013RS015XX6TTPBA112	28.00	34.00	30.55	700PCS



A2013 PA

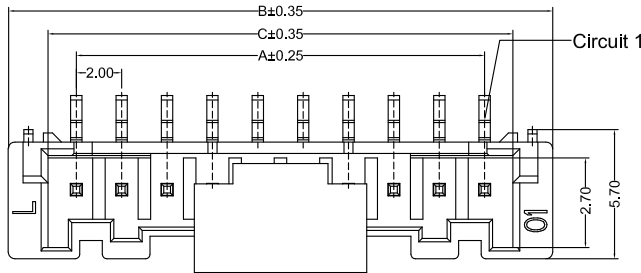
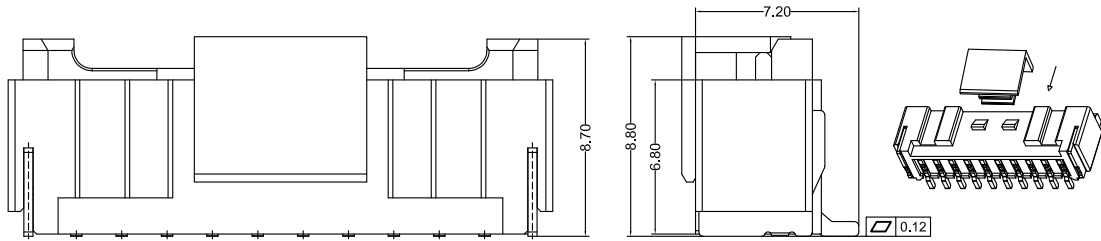

A2013VS_0XX AA 6T TP B A 112

PIN
002=2PINS

SPECIAL
AA=NO Special
Material
6T=PA6T 94V-0
Finish
TP=Terminal Tin-Plated

Code
112
Color
A=Natural
Packing
B=Reel Packing

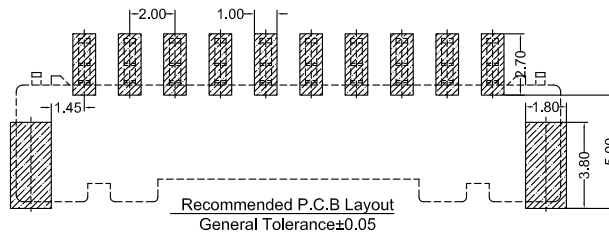

CSG PART NO.	Dimension mm			Qty/Reel
	A	B	C	
A2013VS002AA6TTPBA112	2.00	8.00	4.55	500PCS
A2013VS003AA6TTPBA112	4.00	10.00	6.55	500PCS
A2013VS004AA6TTPBA112	6.00	12.00	8.55	500PCS
A2013VS005AA6TTPBA112	8.00	14.00	10.55	500PCS
A2013VS006AA6TTPBA112	10.00	16.00	12.55	500PCS
A2013VS007AA6TTPBA112	12.00	18.00	14.55	500PCS
A2013VS008AA6TTPBA112	14.00	20.00	16.55	500PCS
A2013VS009AA6TTPBA112	16.00	22.00	18.55	500PCS
A2013VS010AA6TTPBA112	18.00	24.00	20.55	500PCS
A2013VS011AA6TTPBA112	20.00	26.00	22.55	500PCS
A2013VS012AA6TTPBA112	22.00	28.00	24.55	500PCS
A2013VS013AA6TTPBA112	24.00	30.00	26.55	500PCS
A2013VS014AA6TTPBA112	26.00	32.00	28.55	500PCS
A2013VS015AA6TTPBA112	28.00	34.00	30.55	500PCS

