

# A2011 502351 CONNECTOR

2.00mm Pitch/Disconnectable Crimp style connectors

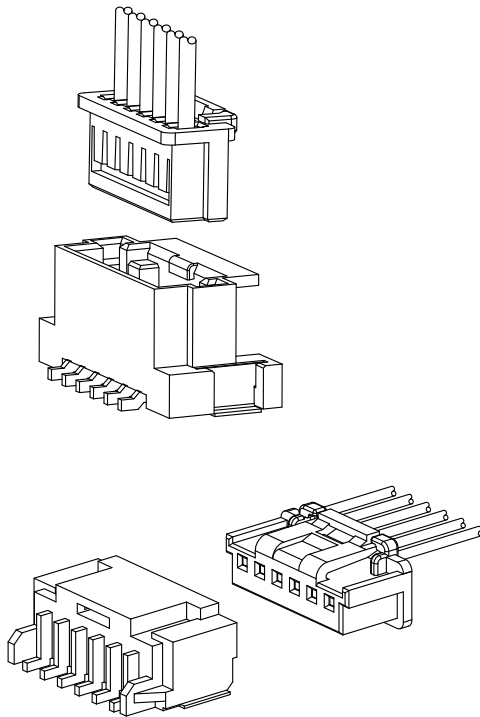

- Secure locking structure
- Low insertion force
- Suction area for picking up
- Improvement of engagement with prying

## Specifications:

- Current rating: 3.0 A / AC,DC (AWG #24)
- Voltage rating: 125 V AC/DC
- Temperature range: -25°C ~ +105°C  
(including temperature rise in applying electrical current)
- Contact resistance: Initial value/ 20m Ω max  
Insulation resistance: 1000 MΩ min  
Withstanding voltage: 500 VAC/minute  
Applicable wire: Conductor size/ AWG#28~#24  
Insulation O.D./ 0.80 to 1.40 mm
- \* Compliant with RoHS2/ HF/ REACH
- \* Refer to "General Instruction and Notice when using Terminals and Connectors"
- \* Contact CSG for details

## Material:

Housing: PA66/ PBT UL94-V0;Color:White  
Applicable Is:PBT UL94-V0;Color:Grey  
Terminal: Phosphor/ Tin-plated  
SMT Wafer Housing: PA9T,UL94-V0;Color:Beige  
SMT Wafer Pin: Brass/ Tin-plated  
SMT Wafer Fixed Foot: Brass/ Tin-plated

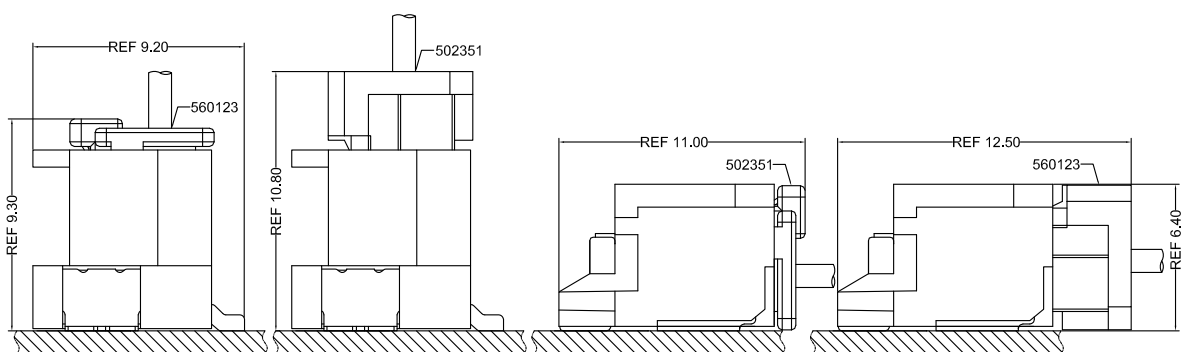

- Note: 1. The above figure is the figure viewed from the connector mounting side.  
2. Tolerances are non-cumulative:  $\pm 0.08$  mm for all centers.  
3. The dimensions above should serve as a guideline. Contact CSG for details.

**CSG**

# A2011 502351

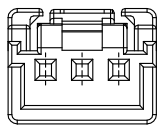
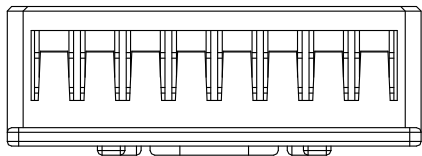
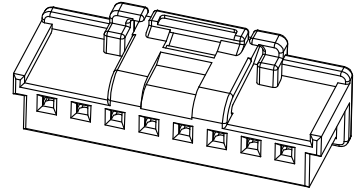
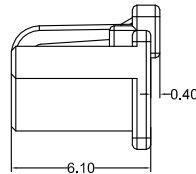
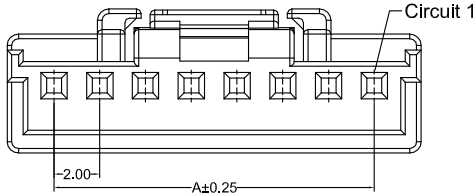
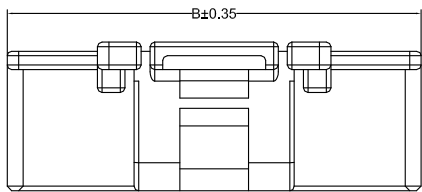

3P-4P

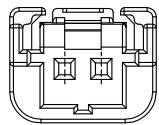

2P

A2011HF 0XX AK P6 9 001  
 PIN 005=5PINS  
 SPECIAL AK=BUCKLE  
 Material P6=PA66 94V-0  
 Code 001  
 Color 9=White

CSG PART NO.	Dimension mm		Q'ty/BAG
	A	B	
A2011HF002AKP69001	2.00	8.00	1000PCS
A2011HF003AKP69001	4.00	10.00	1000PCS
A2011HF004AKP69001	6.00	12.00	1000PCS
A2011HF005AKP69001	8.00	14.00	1000PCS
A2011HF006AKP69001	10.00	16.00	1000PCS
A2011HF007AKP69001	12.00	18.00	1000PCS
A2011HF008AKP69001	14.00	20.00	1000PCS
A2011HF009AKP69001	16.00	22.00	1000PCS
A2011HF010AKP69001	18.00	24.00	1000PCS
A2011HF011AKP69001	20.00	26.00	1000PCS
A2011HF012AKP69001	22.00	28.00	1000PCS
A2011HF013AKP69001	24.00	30.00	1000PCS
A2011HF014AKP69001	26.00	32.00	1000PCS
A2011HF015AKP69001	28.00	34.00	1000PCS

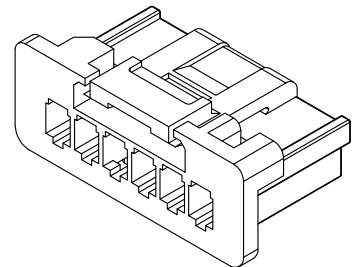
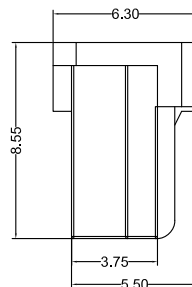
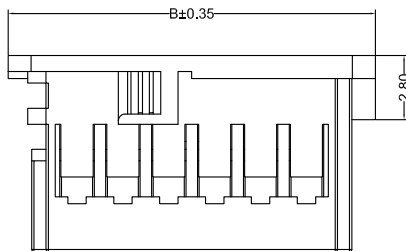
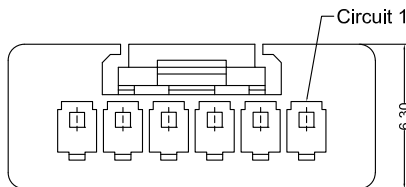

A2011HF 0XX AK PB 9 209  
 PIN 005=5PINS  
 SPECIAL AK=BUCKLE  
 Material PB=PBT 94V-0  
 Code 209  
 Color 9=White

CSG PART NO.	Dimension mm		Q'ty/BAG
	A	B	
A2011HF002AKPB9209	2.00	8.00	1000PCS
A2011HF003AKPB9209	4.00	10.00	1000PCS
A2011HF004AKPB9209	6.00	12.00	1000PCS
A2011HF005AKPB9209	8.00	14.00	1000PCS
A2011HF006AKPB9209	10.00	16.00	1000PCS
A2011HF007AKPB9209	12.00	18.00	1000PCS
A2011HF008AKPB9209	14.00	20.00	1000PCS
A2011HF009AKPB9209	16.00	22.00	1000PCS
A2011HF010AKPB9209	18.00	24.00	1000PCS
A2011HF011AKPB9209	20.00	26.00	1000PCS
A2011HF012AKPB9209	22.00	28.00	1000PCS
A2011HF013AKPB9209	24.00	30.00	1000PCS
A2011HF014AKPB9209	26.00	32.00	1000PCS
A2011HF015AKPB9209	28.00	34.00	1000PCS

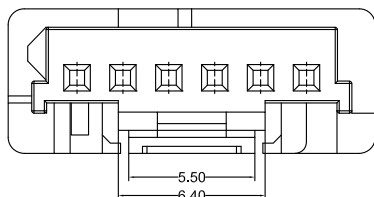

4P-15P

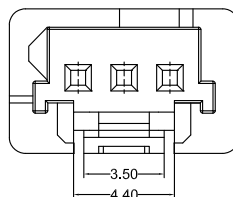

2P-3P



# A2011 502351

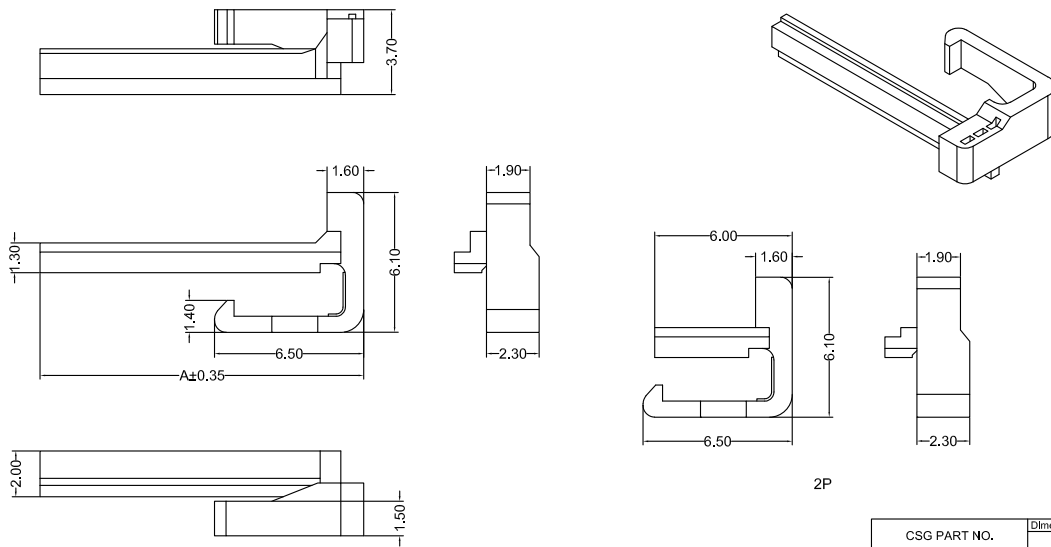

A2011XK 0XX AA PB 8 209

PIN  
005=5PINS  
SPECIAL  
AA=NO Special  
Material  
PB=PBT 94V-0

Code  
209  
Color  
8=Grey

CSG PART NO.	Dimension mm	
	A	Qty/BAG
A2011XK002AAPB8209	6.00	1000PCS
A2011XK003AAPB8209	8.00	1000PCS
A2011XK004AAPB8209	10.00	1000PCS
A2011XK005AAPB8209	12.00	1000PCS
A2011XK006AAPB8209	14.00	1000PCS
A2011XK007AAPB8209	16.00	1000PCS
A2011XK008AAPB8209	18.00	1000PCS
A2011XK009AAPB8209	20.00	1000PCS
A2011XK010AAPB8209	22.00	1000PCS
A2011XK011AAPB8209	24.00	1000PCS
A2011XK012AAPB8209	26.00	1000PCS
A2011XK013AAPB8209	28.00	1000PCS
A2011XK014AAPB8209	30.00	1000PCS
A2011XK015AAPB8209	32.00	1000PCS

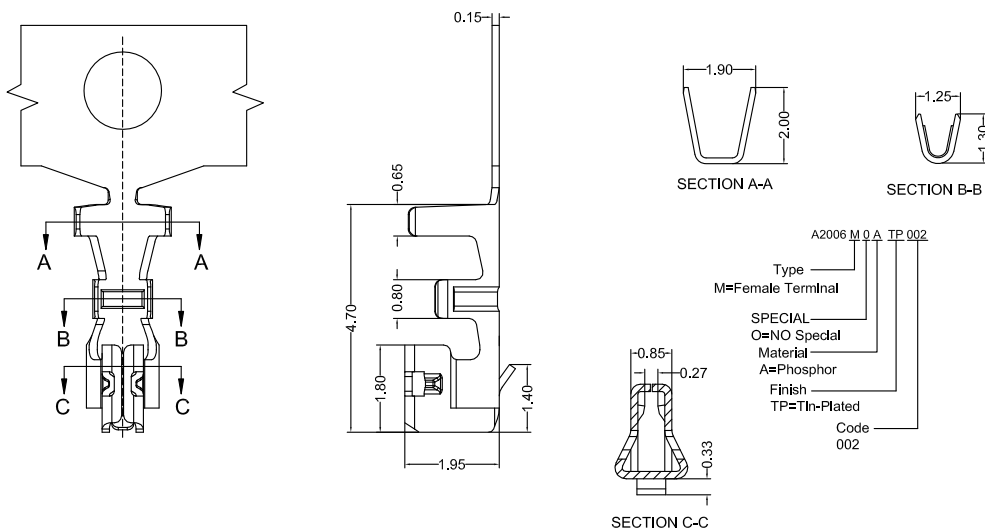

A2006 M 0 A TP.002

Type  
M=Female Terminal

SPECIAL  
O=NO Special

Material  
A=Phosphor

Finish  
TP=TiN-Plated

Code  
002

CSG PART NO.	Wire Range	Insulation O.D.	Qty/Reel
A2006M0ATP002	AWG#24-#26	1.40mm(max)	10000PCS



# A2011 502351

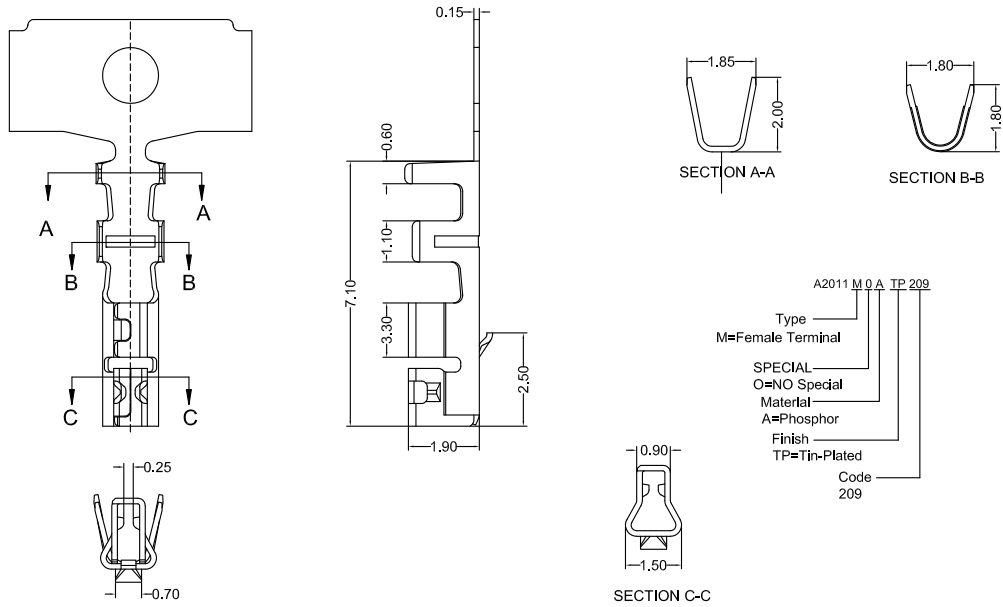

A2011 M O A TP 209

Type  
M=Female Terminal

SPECIAL  
O=NO Special

Material  
A=Phosphor

Finish  
TP=Tin-Plated

Code  
209

CSG PART NO.	Wire Range	Insulation O.D.	Q'ty/Reel
A2011M0ATP001	AWG#24-#26	1.40mm(max)	10000PCS

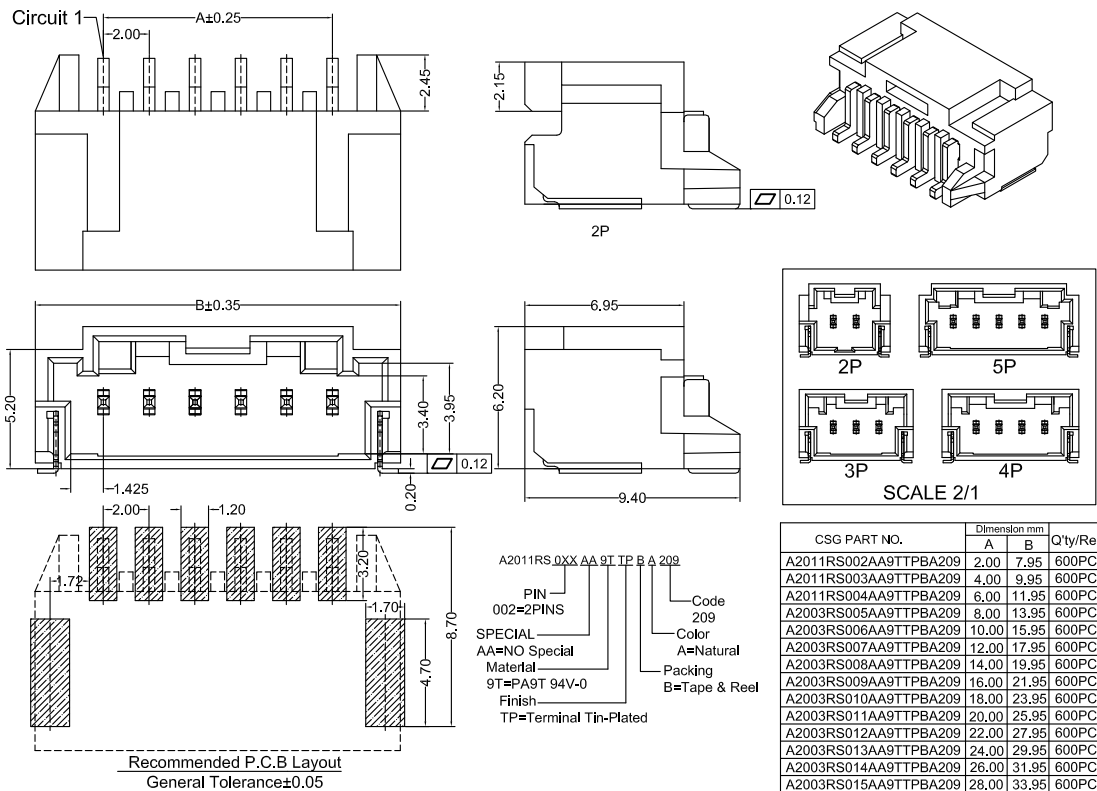

CSG PART NO.	Dimension mm		Q'ty/Reel
	A	B	
A2011RS002AA9TTPBA209	2.00	7.95	600PCS
A2011RS003AA9TTPBA209	4.00	9.95	600PCS
A2011RS004AA9TTPBA209	6.00	11.95	600PCS
A2003RS005AA9TTPBA209	8.00	13.95	600PCS
A2003RS006AA9TTPBA209	10.00	15.95	600PCS
A2003RS007AA9TTPBA209	12.00	17.95	600PCS
A2003RS008AA9TTPBA209	14.00	19.95	600PCS
A2003RS009AA9TTPBA209	16.00	21.95	600PCS
A2003RS010AA9TTPBA209	18.00	23.95	600PCS
A2003RS011AA9TTPBA209	20.00	25.95	600PCS
A2003RS012AA9TTPBA209	22.00	27.95	600PCS
A2003RS013AA9TTPBA209	24.00	29.95	600PCS
A2003RS014AA9TTPBA209	26.00	31.95	600PCS
A2003RS015AA9TTPBA209	28.00	33.95	600PCS

