

A1256 505565 CONNECTOR

1.25mm Pitch/Disconnectable Crimp style connectors

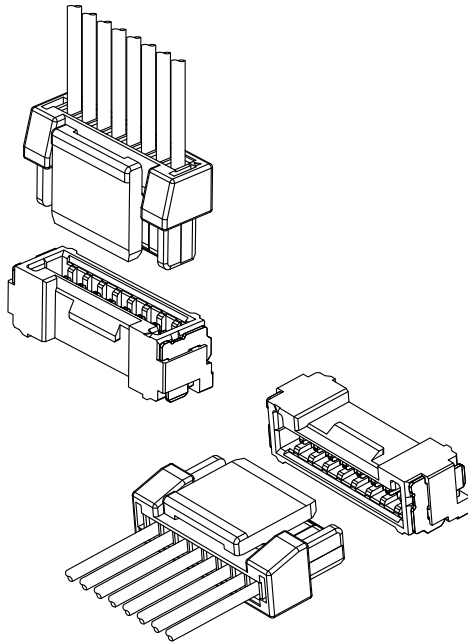

 E529482

Specifications:

- Current rating: 1.5 A / AC,DC
- Voltage rating: 50 V AC/DC
- Temperature range: -25°C ~ +105°C
(including temperature rise in applying electrical current)
- Contact resistance: Initial value/ 20m Ω max
Insulation resistance: 100 M Ω min
Withstanding voltage: 500 VAC/minute
Applicable wire: Conductor size/ AWG#30~#26
Insulation O.D./ 0.50 to 1.00 mm
- * Compliant with RoHS2/ REACH
- * Refer to "General Instruction and Notice when using Terminals and Connectors"
- * Contact CSG for details

Material:

Housing: PA66/UL94-V0;Color:Black/ Chroma
Terminal: Phosphor/ Tin-plated,Gold-Plated
SMT Wafer Housing: LCP/ PA6T,UL94-V0;
Color:0=Black/ Chroma
SMT Wafer Pin: Brass/ Tin-plated,Gold-Plated
Wafer Fixed Foot: Brass/ Tin-plated

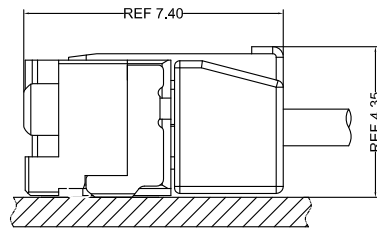
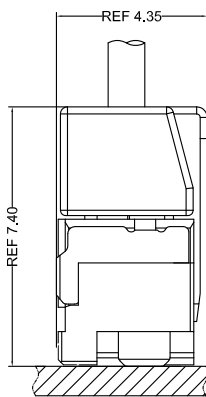

- Note: 1. The above figure is the figure viewed from the connector mounting side.
2. Tolerances are non-cumulative: ± 0.08 mm for all centers.
3. The dimensions above should serve as a guideline. Contact CSG for details.

CSG

A1256 505565

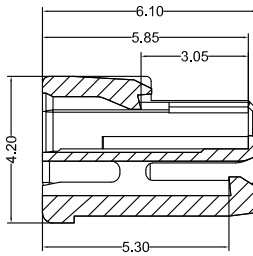
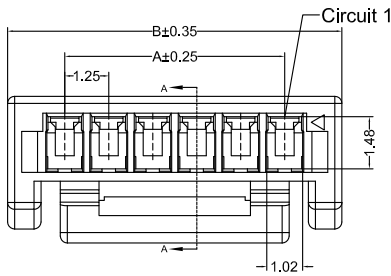

SECTION A-A

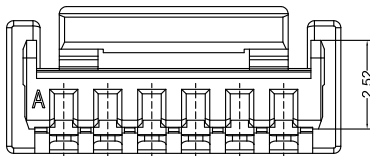
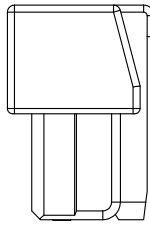
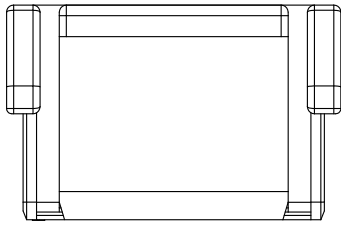
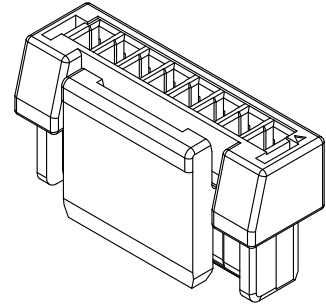

A1256HF 0XX AK P6 X 079
 PIN 005=5PINS
 SPECIAL AK=BUCKLE
 Material P6=PA66 94V-0
 Code 079
 Color 0=Black X=Chroma

CSG PART NO.	Dimension mm		Q'ty/BAG
	A	B	
A1256HF002AKP6X079	1.25	4.50	1000PCS
A1256HF003AKP6X079	2.50	5.75	1000PCS
A1256HF004AKP6X079	3.75	7.00	1000PCS
A1256HF005AKP6X079	5.00	8.25	1000PCS
A1256HF006AKP6X079	6.25	9.50	1000PCS
A1256HF007AKP6X079	7.50	10.75	1000PCS
A1256HF008AKP6X079	8.75	12.00	1000PCS
A1256HF009AKP6X079	10.00	13.25	1000PCS
A1256HF010AKP6X079	11.25	14.50	1000PCS
A1256HF011AKP6X079	12.50	15.75	1000PCS
A1256HF012AKP6X079	13.75	17.00	1000PCS
A1256HF013AKP6X079	15.00	18.25	1000PCS
A1256HF014AKP6X079	16.25	19.50	1000PCS
A1256HF015AKP6X079	17.50	20.75	1000PCS
A1256HF016AKP6X079	18.75	22.00	1000PCS

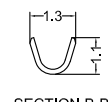
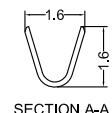
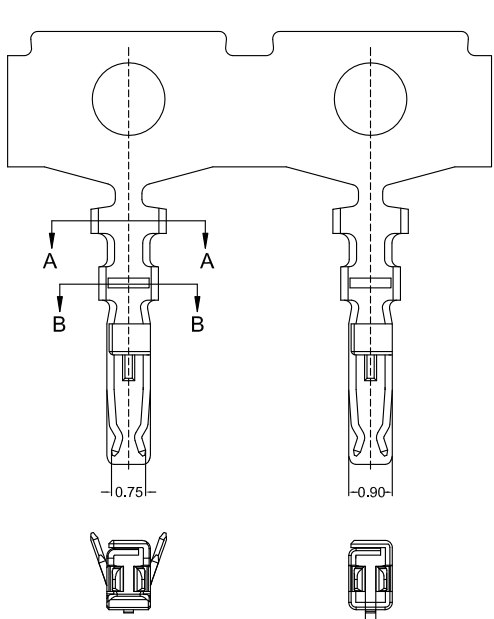

SECTION A-A

SECTION B-B

A1256 M 0 Δ XX 002
 Type M=Female Terminal
 Material A=Phosphor
 Finish TP=Tin-Plated GF=Gold-Plated G/F
 Code 002

CSG PART NO.	Wire Range	Insulation O.D.	Q'ty/Reel
A1256M0ATP002	AWG#26-#30	1.00mm(max)	20000PCS
A1256M0AGF002	AWG#26-#30	1.00mm(max)	20000PCS



A1256 505565

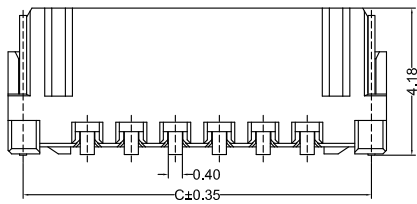
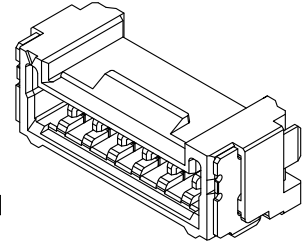
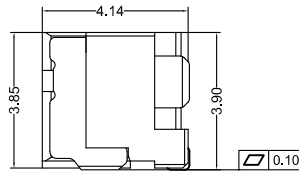
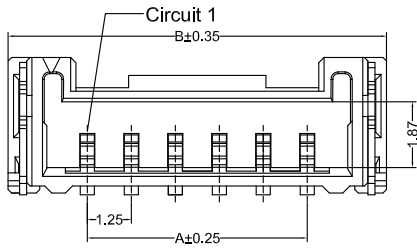

A1256RS 0XX AA XX XX B X 001

PIN
005=5PINS
SPECIAL
AA=NO Special
Material
LP=LCP 94V-0
6T=PA6T 94V-0

Code
001
Color
0=Blakc
X=Chroma
Packing
B=Tape & Reel

Finish
TP=Terminal Tin-Plated
GF=Terminal Gold-Plated

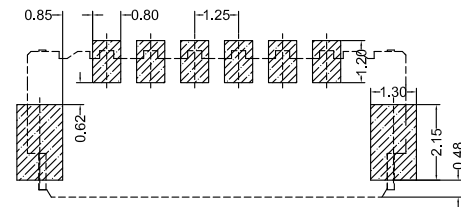

Recommended P.C.B Layout
General Tolerance±0.05

CSG PART NO.	Dimension mm			Q'ty/Reel
	A	B	C	
A1256RS002AAXXXBX001	1.25	5.75	4.90	1500PCS
A1256RS003AAXXXBX001	2.50	7.00	6.15	1500PCS
A1256RS004AAXXXBX001	3.75	8.25	7.40	1500PCS
A1256RS005AAXXXBX001	5.00	9.50	8.65	1500PCS
A1256RS006AAXXXBX001	6.25	10.75	9.90	1500PCS
A1256RS007AAXXXBX001	7.50	12.00	11.15	1500PCS
A1256RS008AAXXXBX001	8.75	13.25	12.40	1500PCS
A1256RS009AAXXXBX001	10.00	14.50	13.65	1500PCS
A1256RS010AAXXXBX001	11.25	15.75	14.90	1500PCS
A1256RS011AAXXXBX001	12.50	17.00	16.15	1500PCS
A1256RS012AAXXXBX001	13.75	18.25	17.40	1500PCS
A1256RS013AAXXXBX001	15.00	19.50	18.65	1500PCS
A1256RS014AAXXXBX001	16.25	20.75	19.90	1500PCS
A1256RS015AAXXXBX001	17.50	22.00	21.15	1500PCS
A1256RS016AAXXXBX001	18.75	23.25	22.40	1500PCS

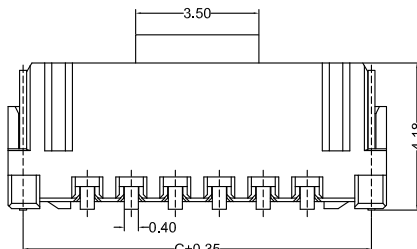
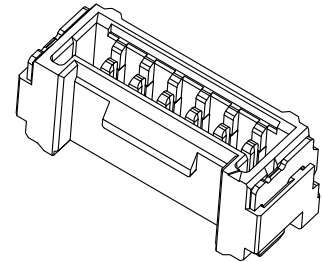
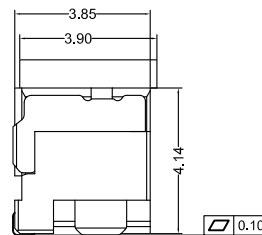
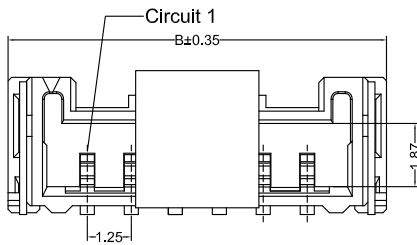

A1256VS 0XX AA XX XX B X 001

PIN
005=5PINS
SPECIAL
AA=NO Special
Material
LP=LCP 94V-0
6T=PA6T 94V-0

Code
001
Color
0=Blakc
X=Chroma
Packing
B=Tape & Reel

Finish
TP=Terminal Tin-Plated
GF=Terminal Gold-Plated

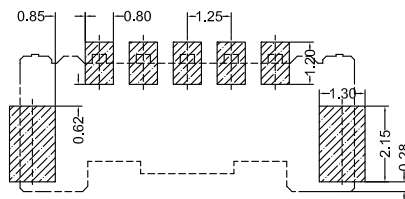

Recommended P.C.B Layout
General Tolerance±0.05

CSG PART NO.	Dimension mm			Q'ty/Reel
	A	B	C	
A1256VS002AAXXXBX001	1.25	5.75	4.90	1200PCS
A1256VS003AAXXXBX001	2.50	7.00	6.15	1200PCS
A1256VS004AAXXXBX001	3.75	8.25	7.40	1200PCS
A1256VS005AAXXXBX001	5.00	9.50	8.65	1200PCS
A1256VS006AAXXXBX001	6.25	10.75	9.90	1200PCS
A1256VS007AAXXXBX001	7.50	12.00	11.15	1200PCS
A1256VS008AAXXXBX001	8.75	13.25	12.40	1200PCS
A1256VS009AAXXXBX001	10.00	14.50	13.65	1200PCS
A1256VS010AAXXXBX001	11.25	15.75	14.90	1200PCS
A1256VS011AAXXXBX001	12.50	17.00	16.15	1200PCS
A1256VS012AAXXXBX001	13.75	18.25	17.40	1200PCS
A1256VS013AAXXXBX001	15.00	19.50	18.65	1200PCS
A1256VS014AAXXXBX001	16.25	20.75	19.90	1200PCS
A1256VS015AAXXXBX001	17.50	22.00	21.15	1200PCS
A1256VS016AAXXXBX001	18.75	23.25	22.40	1200PCS

