

A1005 NH CONNECTOR

1.00mm Pitch/Disconnectable Crimp style connectors

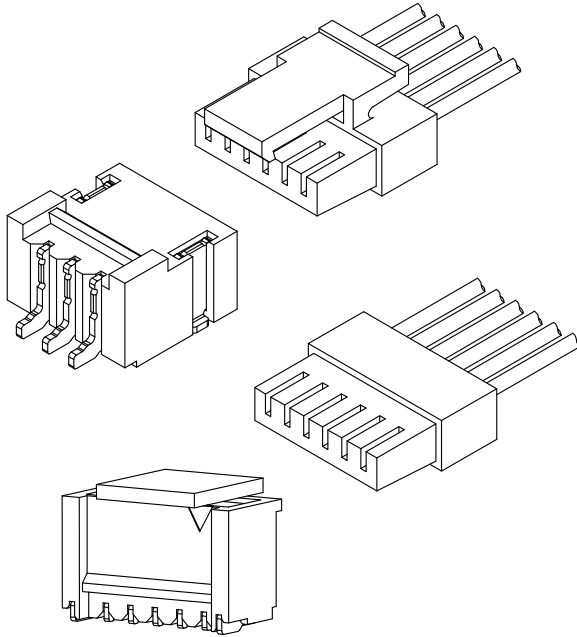

- This connector was upgraded in A1000, adding Buckle to make it more reliable.



Specifications:

- Current rating: 1.0 A AC,DC (AWG #28)
 - Voltage rating: 50 V AC/DC
 - Temperature range: -25°C ~ +105°C
(including temperature rise in applying electrical current)
 - Contact resistance: Initial value/ 20m Ω max
After environmental testing/ 40m Ω max
 - Insulation resistance: 100 M Ω min
 - Withstanding voltage: 500 VAC/minute
 - Applicable wire: Conductor size/ AWG#32 to #28
Insulation O.D./ 0.4 to 0.8 mm
- * Compliant with RoHS2/ HF/ REACH
* In using the products, refer to "Handling Precautions for Terminals and Connectors" described on our website (Technical documents of Product information page).
* Contact CSG for details

Material:

Housing: PA66,UL94-V0;Color:White
Terminal: Phosphor/ Tin-plated, Gold-Plated
Wafer Housing: 6T,UL94-V0;Color:Belge
Wafer Pin: Phosphor/ Tin-plated
Wafer Fixed Foot: Brass/ Tin-plated

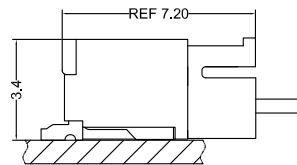
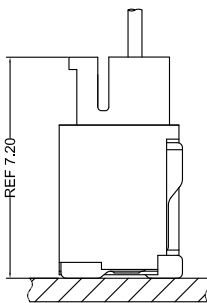

- Note: 1. The above figure is the figure viewed from the connector mounting side.
2. Tolerances are non-cumulative: ± 0.08 mm for all centers.
3. The dimensions above should serve as a guideline. Contact CSG for details.

CSG

A1005 NH

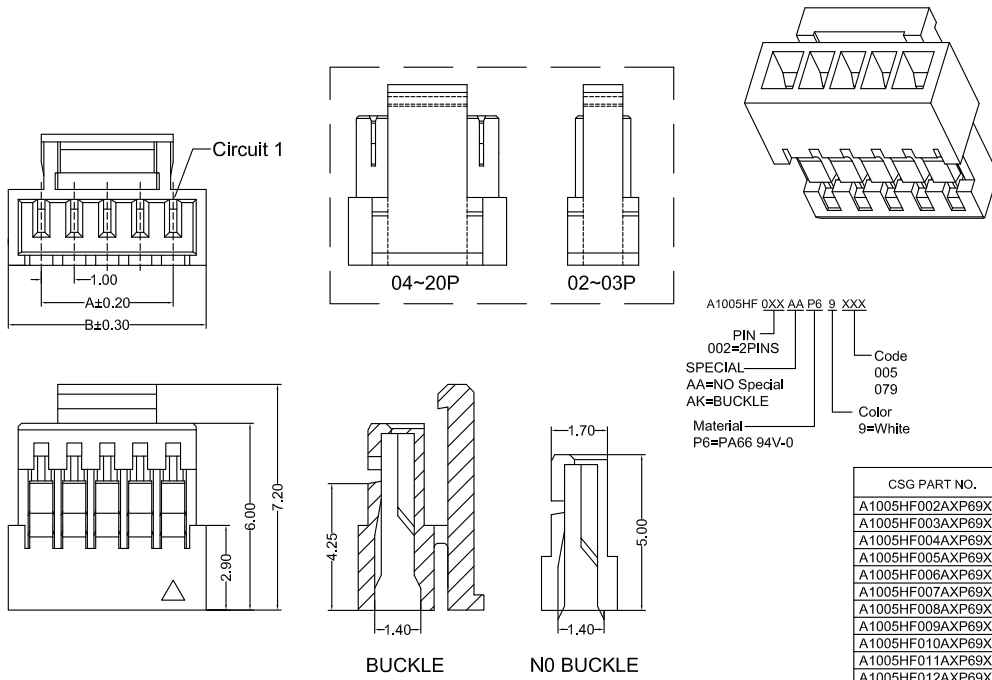

CSG PART NO.	Dimension mm		Q'ty/BAG
	A	B	
A1005HF002AXP69XXX	1.00	3.00	1000PCS
A1005HF003AXP69XXX	2.00	4.00	1000PCS
A1005HF004AXP69XXX	3.00	5.00	1000PCS
A1005HF005AXP69XXX	4.00	6.00	1000PCS
A1005HF006AXP69XXX	5.00	7.00	1000PCS
A1005HF007AXP69XXX	6.00	8.00	1000PCS
A1005HF008AXP69XXX	7.00	9.00	1000PCS
A1005HF009AXP69XXX	8.00	10.00	1000PCS
A1005HF010AXP69XXX	9.00	11.00	1000PCS
A1005HF011AXP69XXX	10.00	12.00	1000PCS
A1005HF012AXP69XXX	11.00	13.00	1000PCS
A1005HF013AXP69XXX	12.00	14.00	1000PCS
A1005HF014AXP69XXX	13.00	15.00	1000PCS
A1005HF015AXP69XXX	14.00	16.00	1000PCS

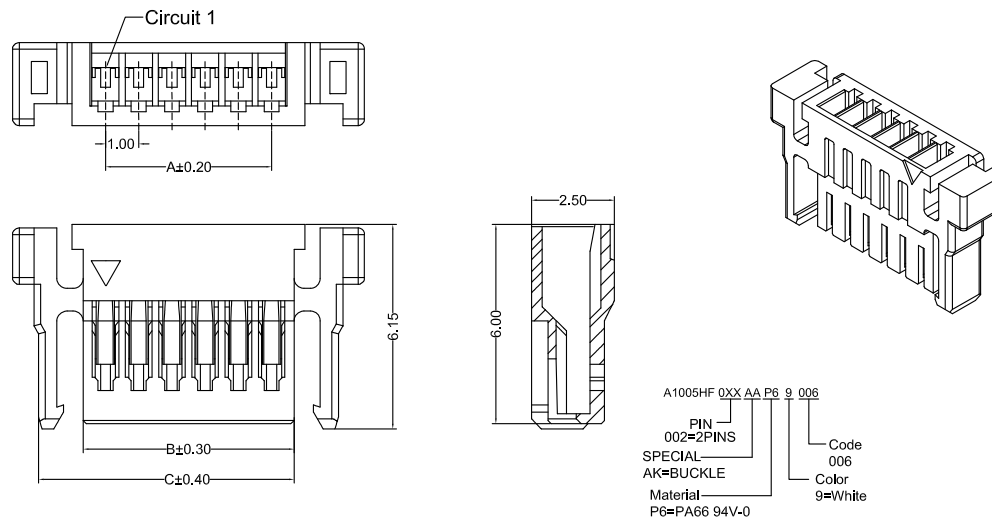

CSG PART NO.	Dimension mm			Q'ty/BAG
	A	B	C	
A1005HF002AKP69006	1.00	2.40	5.00	1000PCS
A1005HF003AKP69006	2.00	3.40	6.00	1000PCS
A1005HF004AKP69006	3.00	4.40	7.00	1000PCS
A1005HF005AKP69006	4.00	5.40	8.00	1000PCS
A1005HF006AKP69006	5.00	6.40	9.00	1000PCS
A1005HF007AKP69006	6.00	7.40	10.00	1000PCS
A1005HF008AKP69006	7.00	8.40	11.00	1000PCS
A1005HF009AKP69006	8.00	9.40	12.00	1000PCS
A1005HF010AKP69006	9.00	10.40	13.00	1000PCS
A1005HF011AKP69006	10.00	11.40	14.00	1000PCS
A1005HF012AKP69006	11.00	12.40	15.00	1000PCS
A1005HF013AKP69006	12.00	13.40	16.00	1000PCS
A1005HF014AKP69006	13.00	14.40	17.00	1000PCS
A1005HF015AKP69006	14.00	15.40	18.00	1000PCS



A1005 NH

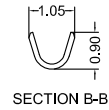
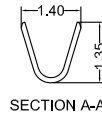
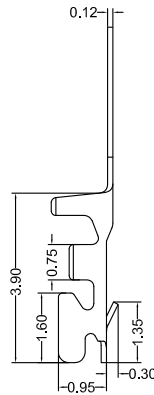
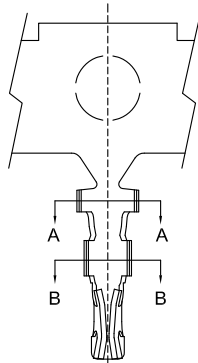

A1005 M 0 A XX 079
 Type
 M=Female Terminal
 Material
 A=Phosphor
 Finish
 TP=Tin-Plated
 GF=Gold-Plated
 Code
 079

CSG PART NO.	Wire Range	Insulation O.D.	Q'ty/Reel
A1005M0ATP079	AWG#28-#32	0.80mm(max)	20000PCS
A1005M0AGF079	AWG#28-#32	0.80mm(max)	20000PCS

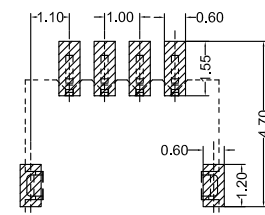
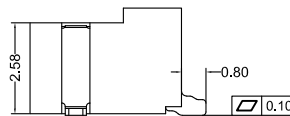
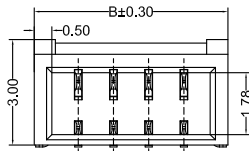
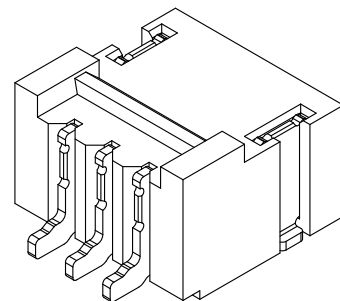
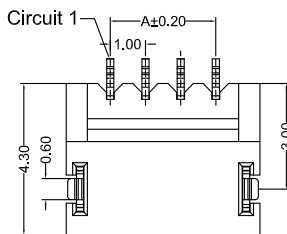

Recommended P.C.B Layout
 General Tolerance±0.05

A1005RS.0XX AA 6T TP B C 112
 PIN
 002=2PINS
 SPECIAL
 AA=NO Special
 Material
 6T=PA6T 94V-0
 Finish
 TP=Terminal Tin-Plated
 Code
 112
 Color
 C=Beige
 Packing
 B=Tape & Reel

CSG PART NO.	Dimension mm		Q'ty/Reel
	A	B	
A1005RS002AA6TTPBC112	1.00	3.50	1500PCS
A1005RS003AA6TTPBC112	2.00	4.50	1500PCS
A1005RS004AA6TTPBC112	3.00	5.50	1500PCS
A1005RS005AA6TTPBC112	4.00	6.50	1500PCS
A1005RS006AA6TTPBC112	5.00	7.50	1500PCS
A1005RS007AA6TTPBC112	6.00	8.50	1500PCS
A1005RS008AA6TTPBC112	7.00	9.50	1500PCS
A1005RS009AA6TTPBC112	8.00	10.50	1500PCS
A1005RS010AA6TTPBC112	9.00	11.50	1500PCS
A1005RS011AA6TTPBC112	10.00	12.50	1500PCS
A1005RS012AA6TTPBC112	11.00	13.50	1500PCS
A1005RS013AA6TTPBC112	12.00	14.50	1500PCS
A1005RS014AA6TTPBC112	13.00	15.50	1500PCS
A1005RS015AA6TTPBC112	14.00	16.50	1500PCS
A1005RS016AA6TTPBC112	15.00	17.50	1500PCS
A1005RS017AA6TTPBC112	16.00	18.50	1500PCS
A1005RS018AA6TTPBC112	17.00	19.50	1500PCS
A1005RS019AA6TTPBC112	18.00	20.50	1500PCS
A1005RS020AA6TTPBC112	19.00	21.50	1500PCS



A1005 NH

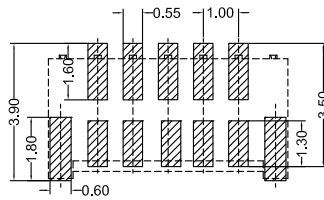
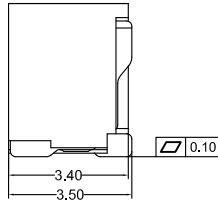
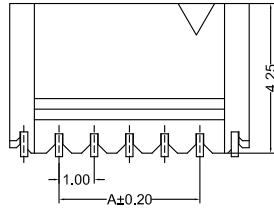
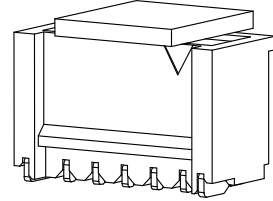
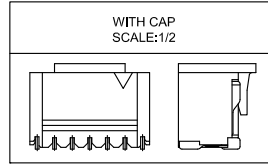
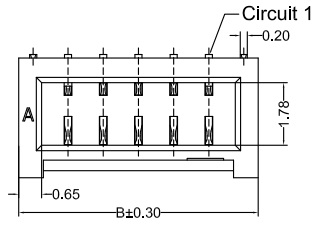

A1005VS.0XX AA 6T TP B C 112

PIN
002=2PINS
SPECIAL
AA=NO Special
Material
6T=PA6T 94V-0
Finish
TP=Terminal Tin-Plated

Code
112
Color
C=Beige
Packing
B=Tape & Reel

Recommended P.C.B Layout
General Tolerance±0.05

CSG PART NO.	Dimension mm		Q'ty/Reel
	A	B	
A1005VS002AA6TTPBC112	1.00	3.80	1500PCS
A1005VS003AA6TTPBC112	2.00	4.80	1500PCS
A1005VS004AA6TTPBC112	3.00	5.80	1500PCS
A1005VS005AA6TTPBC112	4.00	6.80	1500PCS
A1005VS006AA6TTPBC112	5.00	7.80	1500PCS
A1005VS007AA6TTPBC112	6.00	8.80	1500PCS
A1005VS008AA6TTPBC112	7.00	9.80	1500PCS
A1005VS009AA6TTPBC112	8.00	10.80	1500PCS
A1005VS010AA6TTPBC112	9.00	11.80	1500PCS
A1005VS011AA6TTPBC112	10.00	12.80	1500PCS
A1005VS012AA6TTPBC112	11.00	13.80	1500PCS
A1005VS013AA6TTPBC112	12.00	14.80	1500PCS
A1005VS014AA6TTPBC112	13.00	15.80	1500PCS
A1005VS015AA6TTPBC112	14.00	16.80	1500PCS
A1005VS016AA6TTPBC112	15.00	17.80	1500PCS
A1005VS017AA6TTPBC112	16.00	18.80	1500PCS
A1005VS018AA6TTPBC112	17.00	19.80	1500PCS
A1005VS019AA6TTPBC112	18.00	20.80	1500PCS
A1005VS020AA6TTPBC112	19.00	21.80	1500PCS